



*An Online CPD Course
brought to you by
CEDengineering.ca*

Biological Wastewater Treatment II – MBBR Processes

Course No: C04-045
Credit: 4 PDH

Harlan Bengtson, Ph.D., P.E.



Continuing Education and Development, Inc.

P: (877) 322-5800
info@cedengineering.ca

Biological Wastewater Treatment Processes II

MBBR Processes

Harlan H. Bengtson, PhD, P.E.

1. Introduction

Biological wastewater treatment is very widely used for removal of biodegradable materials from wastewater. The first course (Part I) of this series, Biological Wastewater Treatment I – Activated Sludge, starts with a discussion of the biochemical oxygen demand that is created by biodegradable materials in water and the reason why such materials must be removed from wastewater. This course (Part II) of this series is about the Moving Bed Biofilm Reactor (MBBR) wastewater treatment process, including background information about the process and a description of the process, as well as process design calculations for several different configurations of the MBBR process and numerous example calculations.

2. Learning Objectives

At the conclusion of this course, the student will

- Know the differences between attached growth and suspended growth biological wastewater treatment processes
- Be familiar with the components and general configuration of an MBBR wastewater treatment process
- Be able to calculate the loading rate of a wastewater constituent to an MBBR process (in lb/day and g/day) for a specified wastewater flow rate and constituent concentration
- Be able to calculate the required carrier surface area for an MBBR wastewater treatment process for a specified SALR and loading rate
- Be able to calculate the required MBBR tank volume for specified carrier surface area, carrier specific surface area, and the carrier fill %.
- Be able to calculate the liquid volume in an MBBR tank for known tank volume, carrier volume and carrier % void space

- Be able to calculate the BOD, NH₃-N, or NO₃-N removal rate for known values of the surface area removal rate (SARR) and design carrier surface area
- Be able to calculate an estimated effluent BOD, NH₃-N, or NO₃-N concentration based on known values of the appropriate loading rate, estimated removal rate, and design wastewater flow rate
- Be able to make process design calculations for a post-Anoxic denitrification MBBR process, including required tank sizes, estimated effluent concentrations, alkalinity requirement and carbon source requirement
- Be able to make process design calculations for a pre-anoxic denitrification MBBR process, including required tank sizes, estimated effluent concentrations, and alkalinity requirements

3. Topics Covered in this Course

- I. Description of the MBBR (Moving Bed Biofilm Reactor) Process
- II. Single Stage BOD Removal MBBR Process Design Calculations
- III. Two-Stage BOD Removal MBBR Process Design Calculations
- IV. Single Stage Nitrification MBBR Process Design Calculations
- V. Two-Stage BOD Removal and Nitrification MBBR Process Design Calculations
- VI. Denitrification Background Information
- VII. Post-Anoxic Denitrification MBBR Process Design Calculations
- VIII. Pre-Anoxic Denitrification MBBR Process Design Calculations

4. Description of the MBBR (Moving Bed Biofilm Reactor) Process

Initial Development of the MBBR Process: The MBBR process for wastewater treatment was invented and initially developed by Professor Hallvard Ødegaard in the late 1980s at the Norwegian University of Science and Technology. Use of this wastewater treatment process has spread rapidly. Per Ødegaard, 2014 (Reference #1 at the end of this course), there were already more than 800 MBBR wastewater treatment plants in

more than 50 countries in 2014, with about half treating domestic wastewater and about half treating industrial wastewater. At least part of the reason for the interest in the MBBR process is its small footprint in comparison with other biological treatment processes. The tank volume needed for a MBBR process is typically significantly less than that needed for either an activated sludge process or a trickling filter designed to treat the same wastewater flow.

General Description of the MBBR Process: The MBBR process is an attached growth biological wastewater treatment process. That is, the microorganisms that carry out the treatment are attached to a solid medium, as in trickling filter or RBC systems. By contrast, in a suspended growth biological wastewater treatment process, like the activated sludge process, the microorganisms that carry out the treatment are kept suspended in the mixed liquor in the aeration tank.

In the conventional attached growth biological treatment processes, like trickling filter or RBC systems, the microorganisms are attached to a medium that is fixed in place and the wastewater being treated flows past the surfaces of the medium with their attached biological growth. In contrast, an MBBR process utilizes small plastic carrier media (described in more detail in the next section) upon which the microorganisms are attached. The MBBR treatment processes typically take place in a tank similar to an activated sludge aeration tank. The carrier media are kept suspended by a diffused air aeration system for an aerobic process or by a mechanical mixing system for an anoxic or anaerobic process, as illustrated in the figures below. A sieve is typically used at the MBBR tank exit to keep the carrier media in the tank.

Primary clarification is typically used ahead of the MBBR tank. Secondary clarification is also typically used, but there is no recycle activated sludge sent back into the process, because an adequate microorganism population is maintained attached to the media.

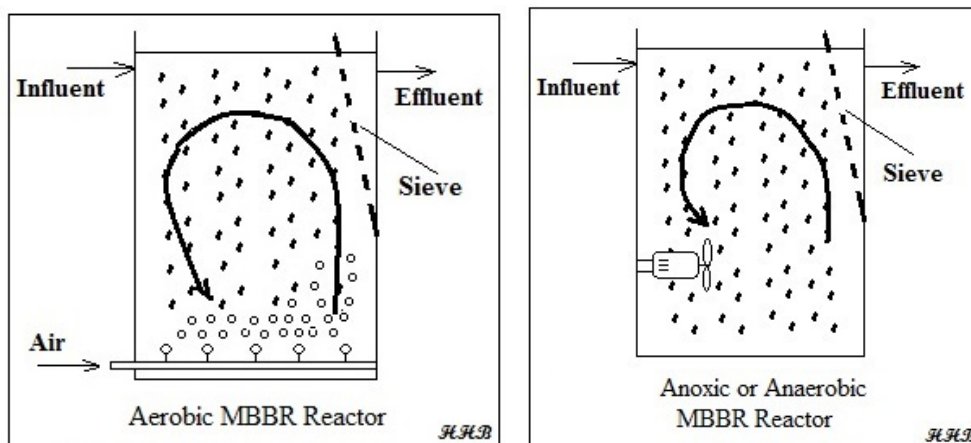

The MBBR Media Support Carrier System: MBBR processes use plastic media support carriers similar to those shown in the figure below. As shown in that figure, the carrier is typically designed to have a high surface area per unit volume, so that there is a lot of surface area on which the microorganisms attach and grow. Media support carriers like those shown in the figure are available from numerous vendors. Two properties of the carrier are needed for the process design calculations to be described and discussed in this course. Those properties are the specific surface area in m^2/m^3 and the void ratio. The specific surface area of MBBR carriers is typically in the range from 350 to 1200 m^2/m^3 and the void ratio typically ranges from 60% to 90%. Design values for these carrier properties should be obtained from the carrier manufacturer or vendor.



Typical MBBR Media Support Carriers

MBBR Wastewater Treatment Process Alternatives: The MBBR wastewater treatment process is quite flexible and can be used in several different ways. The figure below shows flow diagrams for the following six alternatives. Note that, as previously mentioned, primary clarification and secondary clarification are shown for all of the process alternatives, but there is no sludge recycle as in a conventional activated sludge process.

1. Single stage BOD removal
2. Two stage BOD removal
3. Two stage BOD removal and Nitrification
4. Single stage tertiary Nitrification
5. Pre-Anoxic Denitrification
6. Post-Anoxic Denitrification

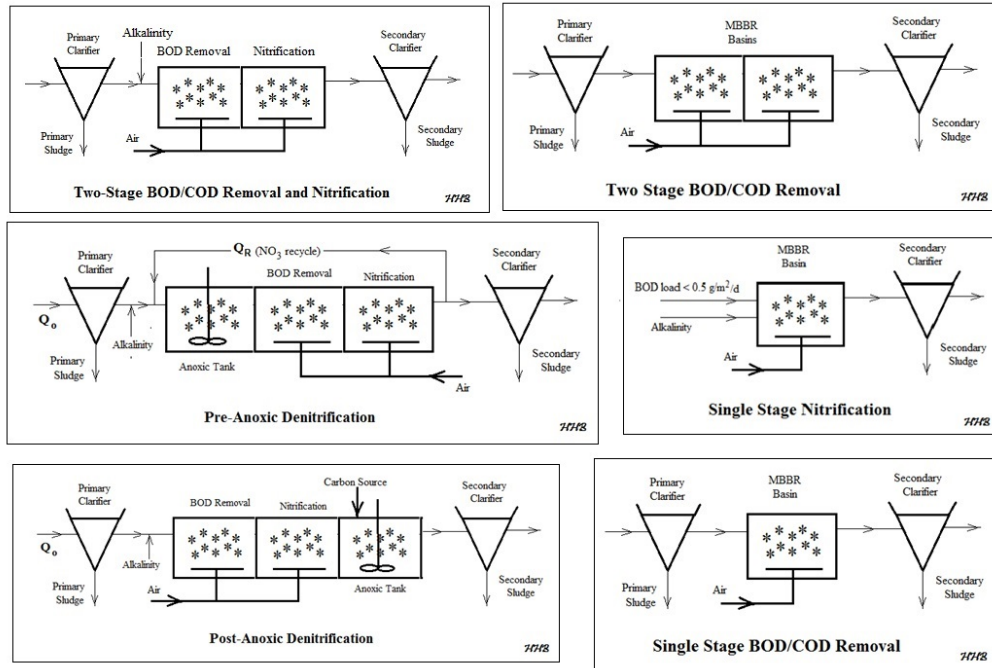

Overview of MBBR Process Design Calculations: The key empirical design parameter used to determine the required MBBR tank size is the surface area loading rate (SALR) in g/m²/d. The g/d in the SALR units refers to the g/d of the parameter being removed and the m² in the SALR units refers to the surface area of the carrier. Thus, for BOD removal the SALR would be g BOD/day entering the MBBR tank per m² of carrier surface area. For a nitrification reactor, the SALR would be g NH₃-N/day entering the MBBR tank per m² of carrier surface area. Finally, for denitrification design, the SALR would be g NO₃-N/day per m² of carrier surface area.

For any of these processes, a design value for SALR can be used together with design values of wastewater flow rate and BOD, ammonia or nitrate concentration, to calculate the required carrier surface area in the MBBR tank. The design carrier volume can then be calculated using a known value for the carrier specific surface area (m²/m³). Finally, a design value for the carrier fill % can be used to calculate the required tank volume.

Process design calculations for each of the process alternatives shown in figure above will be covered in the next several sections.

5. Single Stage BOD Removal MBBR Process Design Calculations

An MBBR single stage BOD removal process may be used as a free-standing secondary treatment process or as a roughing treatment prior to another secondary treatment process, in some cases to relieve overloading of an existing secondary treatment

process. In either case the key design parameter for sizing the MBBR tank is the surface area loading rate (SALR), typically with units of $\text{g}/\text{m}^2/\text{day}$, that is g/day of BOD coming into the MBBR tank per m^2 of carrier surface area. Using design values for wastewater flow rate and BOD concentration entering the MBBR tank, the loading rate in $\text{g BOD}/\text{day}$ can be calculated. Then dividing BOD loading rate in g/day by the SALR in $\text{g}/\text{m}^2/\text{day}$ gives the required carrier surface area in m^2 . The carrier fill %, carrier specific surface area, and carrier % void space can then be used to calculate the required carrier volume, tank volume and the volume of liquid in the reactor. A typical flow diagram for a single stage MBBR process for BOD removal is shown in the figure below.

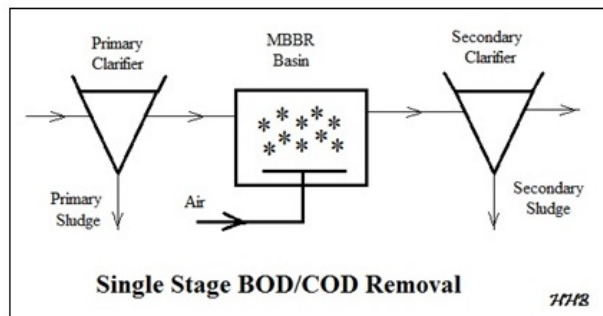

The equations for making those calculations are as follows:

1. BOD loading rate = $Q \cdot S_o \cdot 8.34 \cdot 453.59$

where: **Q** is the wastewater flow rate into the MBBR reactor in MGD

S_o is the BOD concentration in that influent flow in mg/L

8.34 is the conversion factor from mg/L to lb/MG

453.59 is the conversion factor from lb to g

The calculated **BOD loading rate** will be in g/day .

2. required carrier surf. area = BOD Loading Rate/SALR

where: **BOD Loading Rate** is in g/day

SALR is the design surface area loading rate in $\text{g}/\text{m}^2/\text{day}$

The calculated **required carrier surface area** will be in m^2 .

3. required carrier volume = required carrier surf. area/carrier specific surf. area

where: **required carrier surface Area** is in m^2

carrier specific surface Area is in m^2/m^3

The calculated **required carrier volume** will be in m^3 .

4. required tank volume = required carrier volume/carrier fill %

where: **required tank volume** will be in the same units as **required carrier volume**.

5. liquid volume in tank

= required tank volume – [required carrier volume(1 – carrier % void space)]

where: all three volumes will be in the same units.

Note that volumes calculated in m^3 can be converted to ft^3 by multiplying by $3.2808^3 \text{ ft}^3/\text{m}^3$.

Although hydraulic retention time (HRT) is not typically used as a primary design parameter for MBBR reactors, it can be calculated at the design wastewater flow rate, if the liquid volume in the tank is known. Also, if a design peak hour factor is specified, then the HRT at peak hourly flow can be calculated as well. The equations for calculating HRT are as follows:

1. Ave. $\text{HRT}_{\text{des ave}} = \text{liquid vol. in tank} * 7.48 / [Q * 10^6 / (24 * 60)]$

where: **liquid vol. in tank** is in ft^3

Q is in MGD

7.48 is the conversion factor for ft^3 to gal

10^6 is the conversion factor for MG to gal

$24 * 60$ is the conversion factor for days to min

Ave. $\text{HRT}_{\text{des ave}}$ will be in min

2. Ave. $\text{HRT}_{\text{peak hr}} = \text{Ave. } \text{HRT}_{\text{des ave}} / \text{Peak Hour Factor}$

where: **Ave. $\text{HRT}_{\text{peak hr}}$** will also be in min

Table 1 below shows typical SALR design values for BOD removal in MBBR reactors. Reference #2 at the end of this course (Ødegaard, 1999) is the source for the values in the table.

Table 1. Typical Design SALR Values for BOD Removal

Typical Design Values for MBBR reactors at 15°C		
Purpose	Treatment Target % Removal	Design SALR g/m ² -d
BOD Removal		
High Rate	75 - 80 (BOD ₇)	25 (BOD ₇)
Normal Rate	85 - 90 (BOD ₇)	15 (BOD ₇)
Low Rate	90 - 95 (BOD ₇)	7.5 (BOD ₇)

Example #1: A design wastewater flow of 1.5 MGD containing 175 mg/L BOD (in the primary effluent) is to be treated in an MBBR reactor.

- What is the BOD loading rate to the reactor in g/day?
- What would be a suitable design SALR to use for a target of 90-95% removal?
- If the MBBR carrier has a specific surface area of 600 m²/m³ and design carrier fill % of 40%, what would be the required volume of carrier and required MBBR tank volume?
- If the design carrier % void space is 60%, what would be the volume of liquid in the MBBR reactor?
- If the design peak hour factor is 4, calculate the average hydraulic retention time at design average wastewater flow and at design peak hourly wastewater flow.

Solution:

- The BOD loading rate will be $(1.5 \text{ MGD})(175 \text{ mg/L})(8.34 \text{ lb/MG/mg/L}) = 2189 \text{ lb/day} = (2189 \text{ lb/day})(453.59 \text{ g/lb}) = \underline{\underline{993,000 \text{ g BOD/day}}}$
- From **Table 1** above, a suitable design SALR value for BOD removal with a target BOD removal of 90–95% would be 7.5 g/m²/day
- Required carrier surface area = $(993,000 \text{ g/day})/(7.5 \text{ g/m}^2/\text{day}) = 132,403 \text{ m}^2$.
Required carrier volume = $132,403 \text{ m}^2/600 \text{ m}^2/\text{m}^3 = \underline{\underline{220.7 \text{ m}^3}}$

For 40% carrier fill: Required tank volume = $220.7 \text{ m}^3/0.40 = \underline{\underline{551.7 \text{ m}^3}}$.

- The volume of liquid in the reactor can be calculated as:
tank volume – [carrier volume(1 – void %)], Thus the volume of liquid is:
 $551.7 - [220.7(1 - 0.60)] = \underline{\underline{463.4 \text{ m}^3}} = 463.3(3.2808^3) = \underline{\underline{16,365 \text{ ft}^3}}$

e) The HRT at design ave ww flow can be calculated as:

$$\begin{aligned} \text{HRT}_{\text{des ave}} &= \text{reactor liquid volume} * 7.48 / [Q * 10^6 / (24 * 60)] \\ &= 16,365 * 7.48 / [1.5 * 10^6 / (24 * 60)] = \underline{\underline{118 \text{ min}}} \end{aligned}$$

$$\text{HRT}_{\text{peak hr}} = \text{HRT}_{\text{des ave}} / \text{peak hour factor} = 118 / 4 = \underline{\underline{29 \text{ min}}}$$

Use of an Excel Spreadsheet: The type of calculations just discussed can be done conveniently using an Excel spreadsheet. The screenshot on the next page shows an example Excel spreadsheet set up to make the calculations as just described for **Example #1**.

The worksheet shown in the screenshot is set up for user input values to be entered in the blue cells with the values in the yellow cells calculated by the spreadsheet using the equations presented and discussed above. The values calculated by the spreadsheet for the following parameters are the same as those shown in the solution to **Example #1** above: i) the BOD loading in g/day, ii) the required tank volume, iii) the liquid volume in the tank, iv) the hydraulic retention time at design average flow, and v) the hydraulic retention time at peak hourly flow.

You may have noticed that there are a few additional calculations in the worksheet screenshot. If the user selects “rectangular” for the tank shape, the worksheet calculates the tank length and width for the calculated required tank volume. If the user selects cylindrical as the tank shape, the worksheet will calculate the tank diameter. These calculations simply use the formulas for the volume of a rectangular tank ($V = L * W * H$) or for the volume of a cylindrical tank ($V = \pi D^2 H / 4$), with user entered values for L:W ratio being used for rectangular tank calculations and the user entered value for the liquid depth in the tank, H, being used by both. The worksheet also calculates an estimated effluent BOD concentration. The effluent BOD calculation is discussed in the next section.

Estimation of Effluent Concentration: Use of an estimated surface area removal rate (SARR) allows calculation of the estimated effluent concentration of the parameter being removed. That is, for BOD removal, the estimated effluent BOD concentration can be calculated. For nitrification, the estimated effluent ammonia nitrogen concentration can be calculated and for denitrification, the estimated effluent nitrate nitrogen concentration can be calculated.

MBBR Process Design Calculations - U.S. units					
Single-Stage Process for BOD Removal					
Instructions: Enter values in blue boxes. Spreadsheet calculates values in yellow boxes					
1. General Inputs					
Data points for SARR/SALR vs SALR					
Design ww Flow Rate, Q =	1.5	MGD	SALR (g/m ² /d):	7.5	15.0
Prim. Effl. BOD, S_o =	175	mg/L	SARR/SALR:	0.925	0.875
Peak Hour Factor =	4		(default values above are based on the table of typical values of % BOD removal vs SALR at the right)		
Design Value of BOD Surface			Slope, SARR/SALR vs SALR:	-0.007	
Area Loading Rate (SALR) =	7.5	g/m ² /d	Intercept, SARR/SALR vs SALR:	0.975	
See information on typical design values for SALR below right.			Est. of SARR/SALR Ratio =	0.925	
			(Surf. Area Removal Rate/Surf. Area Loading Rate) (for SALR value specified at left)		
2. Calculation of Carrier Volume and Required Tank Volume & Dimensions					
Inputs					
			Liquid Depth in Tank =	8	ft
Carrier Spec. Surf. Area =	600	m ² /m ³	Tank L:W ratio =	1.5	
(value from carrier mfr/vendor)			(target L:W - only used if tank is rectangular)		
Design Carrier Fill % =	40%		Click on green box and then on arrow to Select Tank Shape:	rectangular	
(Carrier fill % is typically between 30% and 70%. Lower values are more conservative, allowing future capacity expansion or reduction of SALR by adding more carrier.)			Carrier % Void Space =	60%	
			(from carrier mfr/vendor - only needed to calculate hydraulic detention time)		
Calculations					
BOD Daily Loading =	2189	lb/day	Calculated Tank Volume =	551.7	m ³
	993,022	g/day	=	19,482	ft ³
			=	145,723	gal
Carrier Surf. Area needed =	132,403	m ²	Calculated Tank Width =	40.3	ft
Calculated Carrier Volume =	220.7	m ³	Calculated Tank Length =	60.4	ft
Tank Liquid Volume =	16,365	ft ³	Nominal Hydraulic Retention Time at		
	463.4102	16364.58	Design Average Flow =	118	min
Estimate of BOD Surface Area			Peak Hourly Flow =	29	min
Removal Rate, SARR =	6.94	g/m ² /d			
Est. of BOD Removal Rate:	918,545	g/day	Calculated Effl BOD Conc.:	13	mg/L
	2025.1	lb/day	If the calculated Effl. BOD conc. is too high, the design value of SALR (in cell C13) should be reduced.		

Screenshot of MBBR Process Design Calculations – Single Stage BOD Removal

Based on graphs and tables provided in several of the references at the end of this document, the SARR/SALR ratio for all of the different types of MBBR treatment being covered in this course ranges from about 0.8 to nearly 1.0 over the range of SALR values typically used. The SARR/SALR ratio is nearly one at very low SALR values and decreases as the SALR value increases.

The upper right portion of the screenshot on the previous page illustrates an approach for estimating a value for the SARR/SALR ratio for a specified design value of SALR. In the four blue cells at the upper right, two sets of values for SARR/SALR and SALR are entered. In this case they are based on the typical values of % BOD removal vs SALR in Table 1 above. In the yellow cells below those entries, the slope and intercept of a SARR/SALR vs SALR straight line are calculated using the Excel SLOPE and INTERCEPT functions. Then the SARR/SALR ratio is calculated for the specified design value of SALR.

Note that the ratio SARR/SALR is equal to the % BOD removal expressed as a fraction. This can be shown as follows:

$$\text{BOD removal rate in g/day} = (\text{SARR in g/m}^2/\text{d})(\text{Carrier Surf. Area in m}^2)$$

$$\text{BOD rate into plant in g/day} = (\text{SALR in g/m}^2/\text{d})(\text{Carrier Surf. Area in m}^2)$$

$$\begin{aligned}\% \text{ BOD removal} &= (\text{BOD removal rate}/\text{BOD rate into plant}) * 100\% \\ &= (100\%)(\text{SARR} * \text{Carrier Surf Area}) / (\text{SALR} * \text{Carrier Surf Area}) \\ &= (\text{SARR}/\text{SALR}) 100\%\end{aligned}$$

Thus, the value of **0.925** for the **SARR/SALR** ratio at **SALR = 7.5 g/m²/d** was obtained from **Table 1** above as the midpoint of the 90-95% estimated % BOD removal for **SALR = 7.5 g/m²/d**. Similarly, the value of **0.875** for the **SARR/SALR** ratio at **SALR = 15 g/m²/d** was obtained from **Table 1** above as the midpoint of the 85-90% estimated % BOD removal for **SALR = 15 g/m²/d**.

At the bottom of the screenshot worksheet, the estimated value of the surface area removal rate (SARR) is calculated. It is used to calculate an estimated BOD removal rate in g BOD/day and lb BOD/day. Then an estimate of the effluent BOD concentration is calculated. The equations for these calculations are as follows:

1. Estimated SARR = (calculated SARR/SALR)(design value of SALR)
2. Estimated BOD removal rate = (estimated SARR)(carrier surface area)

3. Estimated effluent BOD conc.
 = [(BOD loading rate - estimated BOD removal rate)/Q_o]/8.34

Example #2: Calculate the estimated effluent BOD concentration for the wastewater flow described in **Example #1** being treated in the MBBR reactor sized in **Example #1**.

Solution: The solution is included in the spreadsheet screenshot that was used for the solution to **Example #1** above. The pair of points for **SARR/SALR vs SALR** that were discussed above and are shown on the screenshot lead to the following values for the slope and intercept for the **SARR/SALR vs SALR** line: **Slope = -0.007, Intercept = 0.975**.

Thus the estimated **SARR/SALR** ratio for the given **SALR** value of **7.5 g/m²/d** would be calculated as: **SARR/SALR = - (0.007)(7.5) + 0.975 = 0.925**

The SARR value can be calculated as:

$$\text{SARR} = (\text{SARR/SALR})(\text{SALR}) = (0.925)(7.5) = 6.94 \text{ g/m}^2/\text{d}$$

Then, the estimated BOD removal rate can be calculated as:

$$\begin{aligned} \text{Est BOD removal rate} &= (\text{est SARR})(\text{carrier surface area}) \\ &= (6.94 \text{ g/m}^2/\text{d})(132,403 \text{ m}^2) = 918,545 \text{ g/d} = 918,545/453.59 \text{ lb/day} \end{aligned}$$

$$\text{Est BOD removal rate} = 2025.1 \text{ lb/day}$$

The estimated effluent BOD concentration can then be calculated from the equation:

$$\text{Est effluent BOD conc.} = [(\text{BOD loading rate} - \text{est BOD removal rate})/Q_o]/8.34$$

Substituting calculated and given values:

$$\text{Est. effluent BOD conc.} = [(2189 - 2026.1)/1.5]/8.34 = 13 \text{ mg/L}$$

Note that this **13 mg/L** value for the **estimated effluent BOD** concentration is shown near the bottom of the spreadsheet screenshot.

6. Two-Stage BOD Removal MBBR Process Design Calculations

A two stage MBBR BOD removal process may be used instead of a single stage process. In this case, a high SALR “roughing” treatment will typically be used for the first stage and a lower SALR will typically be used for the second stage. This will result in less total tank volume needed for a two-stage process than for a single stage process. Also, a two-stage

MBBR process can typically achieve a lower effluent BOD concentration than a single stage MBBR process. A typical flow diagram for a two-stage MBBR process for BOD removal is shown in the figure below.

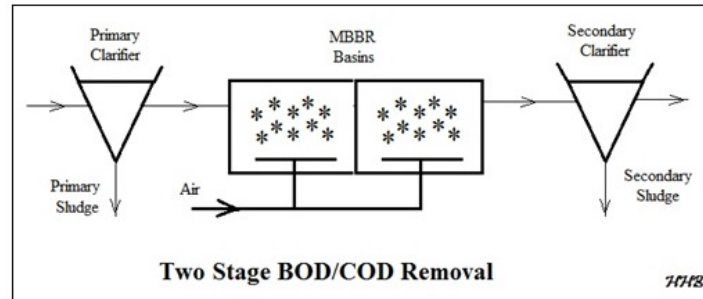

Two Stage MBBR Process for BOD/COD Removal

The process design calculations for a two stage MBBR process are essentially the same for each of the stages as for the single stage process, as described in the previous section. These calculations are illustrated in **Example #3**.

Example #3: A design wastewater flow of 1.5 MGD containing 175 mg/L BOD (in the primary effluent) is to be treated for BOD removal in a two-stage MBBR reactor. The SALR for the first stage is to be 25 g/m²/d and the design SALR for the second stage is to be 7.5 g/m²/d.

a) For the first stage calculate each of the following:

- i) The BOD loading
- ii) The required carrier volume for a carrier with specific surface area of 600 m²/m³
- iii) The required MBBR tank volume for a design carrier fill % of 40%
- iv) The volume of liquid in the MBBR reactor for design carrier % void space of 60%.
- v) The average hydraulic retention time at design average wastewater flow and at design peak hourly flow if the design peak hour factor is 4.
- vi) The estimated effluent BOD concentration from the first stage.

b) Calculate the same parameters for the second stage.

Solution: The solution as calculated with an Excel spreadsheet is shown in the spreadsheet screenshot in the next two figures below.. The first screenshot below which is the top part of the spreadsheet, shows primarily the user input values. It also includes the calculation of the slope and intercept for the SARR/SALR vs SALR equation and the

calculation of the estimated SARR for each stage. These calculations and the resulting SARR/SALR values are the same as those discussed above for the single-stage BOD removal MBBR process. The resulting values for SARR/SALR are **0.775** for the first stage with SALR = **25**, and **0.925** for the second stage with SALR = **7.5**.

The second screenshot figure below is the bottom part of the spreadsheet and shows the calculated values as follows.

a) For the first stage:

i) The BOD loading rate will be $(1.5 \text{ MGD})(175 \text{ mg/L})(8.34 \text{ lb/MG/mg/L}) = 2189 \text{ lb/day} = (2189 \text{ lb/day})(453.59 \text{ g/lb}) = \underline{\underline{993,022 \text{ g BOD/day}}}$

ii) Required carrier surface area = $(993,022 \text{ g/day})/(25 \text{ g/m}^2\text{/day}) = 39,721 \text{ m}^2$.
Required carrier volume = $39,721 \text{ m}^2/600 \text{ m}^2\text{/m}^3 = \underline{\underline{66.20 \text{ m}^3}}$

iii) For 40% carrier fill: Required tank volume = $66.2 \text{ m}^3/0.40 = \underline{\underline{165.5 \text{ m}^3}}$.

iv) The volume of liquid in the reactor can be calculated as:
tank volume – [carrier volume(1 – void %)], Thus the volume of liquid is:
 $165.5 - [66.20(1 - 0.60)] = \underline{\underline{139.02 \text{ m}^3}} = 139.02(3.2808^3) = \underline{\underline{4910 \text{ ft}^3}}$

v) The HRT at design ave ww flow can be calculated as:
 $\text{HRT}_{\text{des ave}} = \text{reactor liquid volume} * 7.48 / [Q * 10^6 / (24 * 60)] =$
 $4910 * 7.48 / [1.5 * 10^6 / (24 * 60)] = \underline{\underline{35 \text{ min}}}$

$\text{HRT}_{\text{peak hr}} = \text{HRT}_{\text{des ave}} / \text{peak hour factor} = 35/4 = \underline{\underline{9 \text{ min}}}$

vi) Calculation of the estimated effluent BOD concentration from the first stage as shown above for the single stage process gives a value of **39 mg/L**.

b) For the second stage:

i) The BOD loading rate will be $(1.5 \text{ MGD})(39 \text{ mg/L})(8.34 \text{ lb/MG/mg/L}) = 492.6 \text{ lb/day} = (492.6 \text{ lb/day})(453.59 \text{ g/lb}) = \underline{\underline{223,430 \text{ g BOD/day}}}$

ii) Required carrier surface area = $(223,430 \text{ g/day})/(7.5 \text{ g/m}^2\text{/day}) = 29,791 \text{ m}^2$.
Required carrier volume = $29,791 \text{ m}^2/600 \text{ m}^2\text{/m}^3 = \underline{\underline{49.65 \text{ m}^3}}$

iii) For 40% carrier fill: Required tank volume = $49.65 \text{ m}^3/0.40 = \underline{\underline{124.1 \text{ m}^3}}$.

iv) The volume of liquid in the reactor can be calculated as:
tank volume – [carrier volume(1 – void %)], Thus the volume of liquid is:
 $124.1 - [49.65(1 - 0.60)] = \underline{\underline{104.3 \text{ m}^3}} = 104.3(3.2808^3) = \underline{\underline{3682 \text{ ft}^3}}$

v) The HRT at design ave ww flow can be calculated as:

$$\text{HRT}_{\text{des ave}} = \text{reactor liquid volume} * 7.48 / [Q * 10^6 / (24 * 60)] = 3682 * 7.48 / [1.5 * 10^6 / (24 * 60)] = \mathbf{26 \text{ min}}$$

$$\text{HRT}_{\text{peak hr}} = \text{HRT}_{\text{des ave}} / \text{peak hour factor} = 26 / 4 = \mathbf{7 \text{ min}}$$

Calculation of the estimated effluent BOD concentration from the second stage using the calculation procedure shown above for the single stage process gives a value of **3.0 mg/L**.

MBBR Process Design Calculations - U.S. units			
Two-Stage Process for BOD Removal			
Instructions: Enter values in blue boxes. Spreadsheet calculates values in yellow boxes			
I. Wastewater Parameter Inputs			
1. Parameters for Both First and Second Stage			
Design ww Flow Rate, Q =	1.5	MGD	Peak Hour Factor = 4
2. Parameters for First Stage:			
Prim. Effl. BOD, S _{o1} = 175 mg/L		Data points for SARR/SALR vs SALR	
		SALR (g/m ² /d):	7.5 25.0
		SARR/SALR:	0.925 0.78
(default values above are based on the table of typical values of % BOD removal vs SALR at the right)			
Design Value of BOD Surface Area Loading Rate (SALR) =	25	g/m ² /d	Slope, SARR/SALR vs SALR: -0.009
See information on typical design values for SALR below right.		Intercept, SARR/SALR vs SALR: 0.989	
		Est. of SARR/SALR Ratio = 0.775 (Surf. Area Removal Rate/Surf. Area Loading Rate)	
3. Parameters for Second Stage:			
Design Value of BOD Surface Area Loading Rate (SALR) =	7.5	g/m ² /d	Est. of SARR/SALR Ratio = 0.925 (Surf. Area Removal Rate/Surf. Area Loading Rate)
See information on typical design values for SALR to the right.			
II. Carrier Parameter and Tank Shape Inputs for both First and Second Stages			
Carrier Spec. Surf. Area =	600	m ² /m ³	Click on green box and then on arrow to Select Tank Shape: rectangular
(value from carrier mfr/vendor)			
Liquid Depth in Tank =	8	ft	Carrier % Void Space = 60%
Tank L:W ratio =	1.5		(from carrier mfr/vendor - only needed to calculate hydraulic detention time)
(target L:W - only used if tank is rectangular)			

Screenshot of MBBR Process Design Calculations - Two Stage BOD Removal – Part 1

III. Calculation of Carrier Volume and Required Tank Volume & Dimensions						
1. First Stage Calculations (BOD Removal)				(Carrier fill % is typically between 30% and 70%. Lower values are more conservative, allowing future capacity expansion or reduction of SALR by adding more carrier.		
Design Carrier Fill % =	40%	(for first stage)				
BOD Daily Loading =	2189	lb/day				
	993,022	g/day	Calculated Tank Volume =	165.5	m ³	
Carrier Surf. Area needed =	39,721	m ²	=	5844.7	ft ³	
Calculated Carrier Volume =	66.20	m ³	=	43718	gal	
Tank Liquid Volume =	4910	ft ³	Calculated Tank Width =	22.1	ft	
	139.0231	4909.374	Calculated Tank Length =	33.1	ft	
Estimate of BOD Surface Area			Nominal Hydraulic Retention Time at			
Removal Rate, SARR =	19.38	g/m ² /d	Design Average Flow =	35	min	
Est. of BOD Removal Rate:	769,592	g/day	Peak Hourly Flow =	9	min	
	1696.7	lb/day	Calculated Effl BOD Conc.:	39	mg/L	
			(from First Stage)			
2. Second Stage Calculations (BOD Removal)						
Design Carrier Fill % =	40%	(for second stage)				
BOD Daily Loading =	492.6	lb/day	Calculated Tank Volume =	124.1	m ³	
	223,430	g/day	=	4383.5	ft ³	
Carrier Surf. Area needed =	29,791	m ²	=	32789	gal	
Calculated Carrier Volume =	49.65	m ³	Calculated Tank Width =	19.1	ft	
Tank Liquid Volume =	3682	ft ³	Calculated Tank Length =	28.7	ft	
	104.2673003	3682.031	Nominal Hydraulic Retention Time at			
Estimate of BOD Surface Area			Design Average Flow =	26	min	
Removal Rate, SARR =	6.94	g/m ² /d	Peak Hourly Flow =	7	min	
Est. of BOD Removal Rate:	206,673	g/day	Calculated Effl BOD Conc.:	3.0	mg/L	
	455.6	lb/day	(from Second Stage)			
1st stage tank volume -			If the calculated Effl. BOD conc. is too high for either			
- 2nd stage tank volume =	41.4		stage, the design value of SALR should be reduced			
				for that stage.		
To make the 2nd stage tank volume the same as the first						
stage tank volume, use Excel's Goal Seek process to set						
cell C66 equal to zero by changing the value in cell C54.						

Screenshot of MBBR Process Design Calculations - Two Stage BOD Removal – Part 2

Example #4: Compare the MBBR tank volume, carrier surface area, and estimated effluent BOD concentration for the single stage BOD removal process in **Example #1** with the two-stage BOD removal process treating the same wastewater flow and influent BOD concentration as calculated in **Example #3**.

Solution: The results are summarized below:

	<u>Single Stage Process</u>	<u>Two-Stage Process</u>
MBBR Volume:	19,482 ft ³	10,228 ft ³
Carrier Surf. Area:	132,403 m ²	69,512 m ²
Est. Effl. BOD:	13 mg/L	3 mg/L

Note that the two-stage process requires only about half of the tank volume and half of the carrier quantity in comparison with the single stage process, while achieving a significantly lower estimated effluent BOD.

7. Single Stage Nitrification MBBR Process Design Calculations

An MBBR single stage nitrification process would typically be used as a tertiary treatment process following some type of secondary treatment that reduced the BOD to a suitable level. A typical flow diagram for a single stage MBBR process for nitrification is shown in the figure below. As shown on the diagram, the BOD level should be low enough so that the BOD load to the nitrification process is less than 0.5 g/m²/day. Note that alkalinity is used in the nitrification process and thus alkalinity addition is typically required.

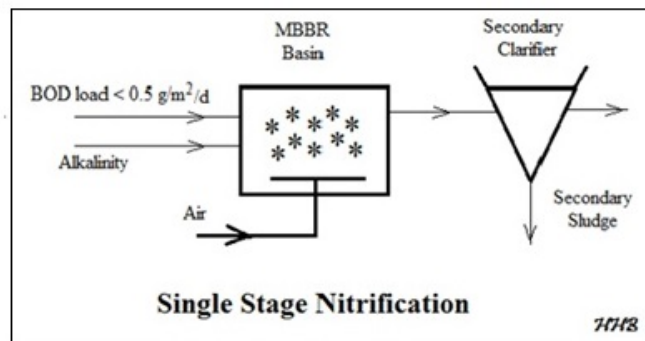

Single Stage MBBR Process for Nitrification

The process design calculations for this single stage MBBR process are similar to those used for the BOD removal processes, but the design SALR value for nitrification can be calculated rather than being selected from a table of typical values, as was done for BOD removal. The design SALR can be calculated using a kinetic model for the surface area removal rate (SARR) as a function of the dissolved oxygen concentration in the MBBR reactor and the bulk liquid ammonia nitrogen concentration, which is equal to the effluent ammonia nitrogen concentration assuming completely mixed conditions in the MBBR tank.

The kinetic model to be discussed here is from Metcalf and Eddy (2014), Figure 9-25 [attributed to Odegaard (2006)] and Equation 9-48. This figure and equation will now be shown and discussed briefly. The figure below was prepared based on Metcalf and Eddy’s Figure 9-25 and their Equation 9-48 (shown below). Note that the figure and equation are for operation at 15°C. Correction of the SARR and SALR for some other operational temperature can be done with the equation: $SARR_T = SARR_{15}\theta^{(T-15)}$ where T is the design operational temperature in °C. From Salvetti, et.al (2006): $\theta = 1.058$ for D.O. limited conditions and $\theta = 1.098$ if ammonia nitrogen concentration is the limiting factor.

Equation 9-48 from Metcalf and Eddy (2014) is:

$$SARR = [N_e / (2.2 + N_e)] * 3.3, \quad N_e = \text{effluent ammonia N conc.}$$

This is the equation for the curved portion at the left in the graph below, which is for ammonia N concentration limiting conditions.

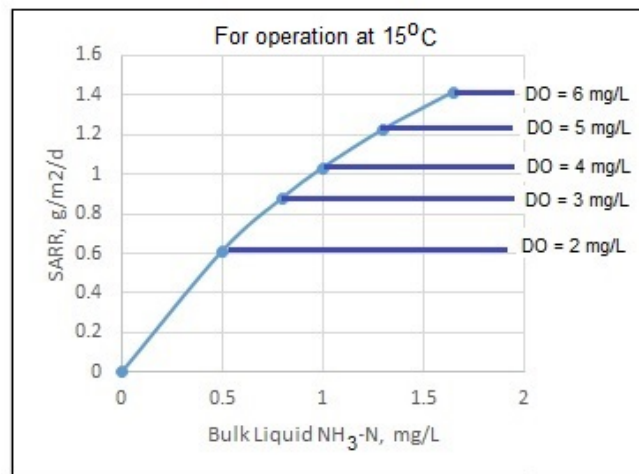

Adapted from Metcalf & Eddy (2014), Fig 9-25

The horizontal lines in the figure above show the nitrification **SARR** under D.O. limiting conditions for each of the D.O. levels shown. The **SARR** will be D.O. limited when the **NH₃-N** concentration is above the value at the left end of the horizontal line for each D.O. level. When the **NH₃-N** concentration is below that value, then the **SARR** is ammonia concentration limited and the **SARR** is a function of the effluent **NH₃-N** concentration (**N_e**) per the equation: **SARR = [N_e / (2.2 + N_e)] * 3.3.**

As shown in **Section 5** for BOD removal, **SALR/SARR = % BOD removal**. Similarly, for nitrification, **SALR/SARR = % NH₃-N removal**. After the **SARR** has been determined, the **SALR** can be calculated as: **SALR = SARR/% removal**.

The maximum **SARR** for each of the D.O. levels shown in the figure above are shown in **Table 2** below, along with the ammonia nitrogen concentration above which the **SARR** will be at that maximum value.

Table 2. Values of **SARR_{max}** and **NH₃-N_e @ SARR_{max}**

D.O.	SARR _{max}	min NH ₃ -N _e @ SARR _{max}
mg/L	g/m ² /d	mg/L
2	0.61	0.5
3	0.88	0.8
4	1.03	1
5	1.23	1.3
6	1.41	1.65

Example #5: A design flow of 0.2 MGD has the following characteristics: 15 mg/L BOD, 25 mg/L NH₃-N, and alkalinity of 140 mg/L as CaCO₃. This flow is to be treated in a single stage nitrification MBBR reactor. The target effluent NH₃-N is 3.3 mg/L. The dissolved oxygen is to be maintained at 3.0 mg/L in the MBBR reactor. The design minimum wastewater temperature is to be 45°F.

- Determine an appropriate NH₃-N surface area loading rate (SALR) for this nitrification process, in g NH₃-N/m²/d.
- What is the NH₃-N loading rate to the reactor in g/day?
- If the MBBR carrier has a specific surface area of 600 m²/m³ and design carrier fill % of 40%, what would be the required volume of carrier and required MBBR tank volume?
- Calculate the BOD surface area loading rate (SALR) to ensure that it is less than 0.5 g BOD/m²/day.
- If the design carrier % void space is 60%, what would be the volume of liquid in the MBBR reactor.
- If the design peak hour factor is 4, calculate the average hydraulic retention time at design average wastewater flow and at design peak hourly wastewater flow.
- Calculate the alkalinity requirement in lb/day as CaCO₃ and in lb/day NaHCO₃ for a target effluent alkalinity of 80 mg/L.

Solution:

The solution is shown in the spreadsheet screenshots below. A summary of the calculations is as follows:

- a) The D.O. limited **SARR** can be obtained as **SARR_{max}** from **Table 2** for the specified D.O level, and the minimum ammonia nitrogen concentration for that **SARR** value can be obtained from the same table. The values from **Table 2**, for a D.O. of 3.0 are: **SARR_{max} = 0.88 g/m²/d** and minimum **NH₃-N_e** for that value of **SARR_{max} = 0.80 mg/L**. (in the worksheet shown in the first screenshot below, these two values are obtained using Excel's VLOOKUP function from a table like **Table 2**, above that is on the worksheet.

The **SARR** for the design D.O. and ammonia nitrogen removal at 15°C will then be equal to **SARR_{max}** if the target effluent ammonia nitrogen concentration is greater than the 0.80 mg/L value determined above. If the target effluent ammonia nitrogen concentration is less than 0.80 mg/L, then the SARR needs to be calculated using Metcalf & Eddy's equation 9-48. In this case, the target effluent NH₃-N of 3.3 mg/L is greater than 0.8 mg/L, so the SARR at 15°C is 0.88 g/m²/d.

The design value for the SARR at the design minimum wastewater temperature can then be calculated as: $SARR_T = SARR_{15} \theta^{(T-15)}$, where the WW temperature must be in °C. Since this case has D.O. limited conditions, $\theta = 1.058$. Carrying out this calculation gives: **design value of SALR = 0.65 g/m²/d**.

- b) The ammonia nitrogen loading rate will be (0.2 MGD)(25 mg/L)(8.34 lb/MG/mg/L) = 41.7 lb/day = (41.7 lb/day)*(453.59 g/lb) = **18,915 g NH₃-N/day**
- c) Required carrier surface area = (18,915 g/day)/(0.65 g/m²/day) = 28,925 m².
 Required carrier volume = 28,925 m²/600 m²/m³. = 48.209 m³
 = (48.209 m³)(3.2808³ ft³/m³) = **1702 ft³**.

For 40% carrier fill: Required tank volume = 1702 ft³/0.40 = **4256 ft³**.

- d) The BOD SALR will be (0.2 MGD)(15 mg/L)(8.34 lb/MG/mg/L)(453.59)/(28925 m²) = **0.39 g/m²/day** (Note that this is less than 0.5 g/m²/day as required.)
- e) The volume of liquid in the reactor can be calculated as:
 tank volume – [carrier volume(1 – void %)], Thus the volume of liquid is:
 4256 – [1702(1 – 0.60)] = **3575 ft³**.

- f) The HRT at design ave ww flow can be calculated as:

$$\begin{aligned} \text{HRT}_{\text{des ave}} &= \text{reactor liquid volume} * 7.48 / [Q * 10^6 / (24 * 60)] \\ &= 3575 * 7.48 / [0.2 * 10^6 / (24 * 60)] = \underline{\mathbf{193 \text{ min}}} \end{aligned}$$

$$\text{HRT}_{\text{peak hr}} = \text{HRT}_{\text{des ave}} / \text{peak hour factor} = 193 / 4 = \underline{\mathbf{48 \text{ min}}}$$

- g) Calculation of the alkalinity requirement is shown in the second screenshot below. The alkalinity needed for nitrification is 7.14 g CaCO₃/g NH₃-N removed. Thus, the alkalinity to be added in mg/L can be calculated as:

$$\mathbf{7.14(\text{mg/L NH}_3\text{-N removed}) + \text{target effl. Alkalinity} - \text{influent alkalinity}}$$

For the given input values, this becomes:

$$7.14(25 - 3.3) + 80 - 140 = \mathbf{94.9 \text{ mg/L as CaCO}_3}$$

The rate of alkalinity addition needed can then be calculated as:

$$(0.2 \text{ MGD})(94.9 \text{ mg/L}) * 8.34 = \underline{\mathbf{158.4 \text{ lb/day as CaCO}_3}}.$$

Multiplying this by the ratio of the equivalent weight of NaHCO₃ (84) to the equivalent weight of CaCO₃ (50) gives the daily NaHCO₃ requirement as:

$$\underline{\mathbf{266.0 \text{ lb/day NaHCO}_3}}.$$

MBBR Process Design Calculations - U.S. units			
Single Stage Tertiary Nitrification Process			
Instructions: Enter values in blue boxes. Spreadsheet calculates values in yellow boxes			
1. General Inputs			
		Peak Hour Factor =	4
		Target Effl NH ₄ -N Conc., NH ₄ -N _e =	3.3 mg/L
Design ww Flow Rate, Q =	0.2 MGD	Min Design Temp., T =	45 °F
Influent NH ₄ -N Conc. =	25 mg/L		
Influent BOD, S ₀ =	15 mg/L	Click on cell H10 and on arrow to select D.O. Co	
Prim. Effl. Alkalinity =	140 mg/L as CaCO ₃	D.O. Conc. in Reactor =	3.0 mg/L
2. Preliminary Calculations - Design SALR value			
% NH ₄ -N removal =	87%	NH ₄ -N _e @ SARR _{max} =	0.80 mg/L
Maximum SARR =	0.88 g/m ² /d	SARR @ NH ₄ -N _e , 15°C, SARR ₁₅ =	0.88 g/m ² /d
		SARR @ NH ₄ -N _e , T °C, SARR _T =	0.57 g/m ² /d
SARR Temp. Coeff, θ =	1.058		
		Design Value for SALR =	0.65 g/m ² /d
3. Calculation of Carrier Volume and Required Tank Volume & Dimensions			
Inputs			
Carrier Spec. Surf. Area =	600 m ² /m ³	Liquid Depth in Tank =	8 ft
(value from carrier mfr/vendor)		Tank L:W ratio =	1.5
		(target L:W - only used if tank is rectangular)	
Design Carrier Fill % =	40%	Click on green box and then on	
(Carrier fill % is typically between 30% and		arrow to Select Tank Shape:	rectangular
70%. Lower values are more conservative,		Carrier % Void Space =	60%
allowing future capacity expansion or		(from carrier mfr/vendor - only needed to	
reduction of SALR by adding more carrier.)		calculate hydraulic detention time)	
Calculations			
NH ₃ -N Daily Loading =	41.7 lb/day	Calculated Tank Volume =	120.5 m ³
	18915 g/day	=	4256.2 ft ³
Carrier Surf. Area needed =	28925 m ²	=	31837 gal
Calculated Carrier Volume =	48.209 m ³	Calculated Tank Width =	18.8 ft
		Calculated Tank Length =	28.2 ft
Tank Liquid Volume =	3575.2 ft ³	Nominal Hydraulic Retention Time at	
		Design Average Flow =	193 min
BOD Surf. Loading Rate (SALR):	0.39 g/m ² /d	Peak Hourly Flow =	48 min
(should be < 0.5 g/m ² /d in order to achieve a good nitrification rate)			

Screenshot of MBBR Process Design Calculations – Single Stage Nitrification – Part 1

5. Alkalinity Requirement			
Input:	Target Effluent Alkalinity =	80	mg/L
Constants needed for Calculations:			
Equiv Wt. of CaCO ₃ =	50	g/equiv.	Equiv Wt. of NaHCO ₃ = 84 g/equiv.
Alkalinity used for Nitrification =	7.14	g CaCO ₃ /g NH ₃ -N	
Calculations			
Alkalinity to be added =	94.9	mg/L as CaCO ₃	
Daily Alkalinity Requirement =	158.4	lb/day as CaCO ₃	
For sodium bicarbonate use to add alkalinity:			
Daily NaHCO ₃ Requirement =	266.0	lb/day NaHCO ₃	

Screenshot of MBBR Process Design Calculations – Single Stage Nitrification – Part 2

8. Two-Stage BOD Removal and Nitrification MBBR Process Design Calculations

A two stage MBBR process may also be used to achieve both BOD removal and nitrification. Nitrification with an MBBR process requires a rather low BOD concentration in order to favor the nitrifying bacteria in the biomass attached to the carrier. Thus, the first stage for this process is used for BOD removal and the second stage is used for nitrification. A typical flow diagram for a two stage MBBR process for BOD removal and nitrification is shown in the figure below. As in the single stage nitrification process alkalinity is used for nitrification, so alkalinity addition is typically required.

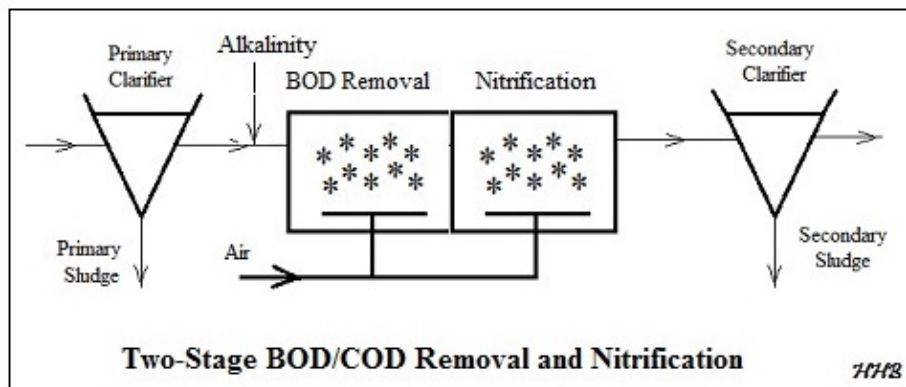

Table 3 shows typical design values for the SALR (surface area loading rate) for the BOD removal stage and for the nitrification stage. The source for the values in this table is the Odegaard reference #2 below. The design SALR value for nitrification, however, will be calculated based on the design D.O concentration and the target effluent NH₃-N concentration, as it was for the single-stage nitrification process.

Table 3. Typical Design SALR Values for Nitrification

Typical Design Values for MBBR reactors at 15°C		
Purpose	Treatment Target % Removal	Design SALR g/m ² -d
Nitrification		
BOD removal stage	90 - 95 (BOD ₇)	6.0 (BOD ₇)
Effl. NH ₃ -N > 3 mg/L	90 (NH ₃ -N)	1.00 (NH ₃ -N)
Effl. NH ₃ -N < 3 mg/L	90 (NH ₃ -N)	0.45 (NH ₃ -N)

The process design calculations for this two stage MBBR process are essentially the same as those described above for the previous examples. **Table 3** will be used to obtain values for SARR/SALR vs SALR for the BOD removal stage as in the previous examples. The design SALR for the nitrification stage will be calculated as it was for the single stage nitrification process.

The process design calculations for this two-stage process are illustrated in **Example #6**.

Example #6: A design wastewater flow of 1.5 MGD has the following primary effluent characteristics: 175 mg/L BOD, 35 mg/L TKN, and alkalinity of 140 mg/L as CaCO₃. The design minimum wastewater temperature is 45°F. This flow is to be treated for BOD removal and nitrification in a two stage MBBR process. The design SALR for the first stage is to be 6 g BOD/m²/d, the target effluent NH₃-N from the second stage is to be 3.3 mg/L and the design DO level in the nitrification stage is to be 3.0 mg/L.

a) For the first (BOD removal) stage calculate each of the following:

- i) The BOD loading
- ii) The required carrier volume for a carrier with specific surface area of 600 m²/m³
- iii) The required MBBR tank volume for a design carrier fill % of 40%
- iv) The volume of liquid in the MBBR reactor for design carrier % void space of 60%.

- v) The average hydraulic retention time at design average wastewater flow and at design peak hourly flow if the design peak hour factor is 4.
 - vi) The estimated effluent BOD concentration from the first stage.
- b) For the second (Nitrification) stage calculate each of the following:
- i) An appropriate $\text{NH}_3\text{-N}$ surface area loading rate (SALR) to be used for this nitrification process, in $\text{g NH}_3\text{-N/m}^2\text{/d}$.
 - ii) The nitrate loading
 - iii) The required carrier volume for a carrier with specific surface area of $600 \text{ m}^2\text{/m}^3$
 - iv) The required MBBR tank volume for a design carrier fill % of 40%
 - v) The volume of liquid in the MBBR reactor for design carrier void space of 60%.
 - vi) The average hydraulic retention time at design average wastewater flow and at design peak hourly flow if the design peak hour factor is 4.
 - vii) The alkalinity requirement in lb/day as CaCO_3 and in lb/day NaHCO_3 .

Solution: The solution, as calculated with an Excel spreadsheet, is shown in the three spreadsheet screenshots on the next several pages. The first screenshot, which is the top part of the spreadsheet, shows primarily the user input values. It includes the calculation of the slope and intercept for the SARR/SALR vs SALR equation and the calculation of the estimated SARR for the BOD removal stage. It also includes calculation of the design SALR value for the nitrification stage. These calculations are carried out as discussed above for the single-stage BOD removal and nitrification MBBR processes. The resulting values for SARR/SALR are **0.935** for the first stage with SALR = **6 g BOD/m²/d**, and **0.63 g/m²/d** for the second stage (nitrification) SALR.

The second screenshot is the bottom part of the spreadsheet and shows the calculated values as follows.

- a) For the first stage:
- i) The BOD loading rate will be $(1.5 \text{ MGD})(175 \text{ mg/L})(8.34 \text{ lb/MG/mg/L}) = 2,189 \text{ lb/day} = (2189 \text{ lb/day})(453.59 \text{ g/lb}) = \underline{\underline{993,022 \text{ g BOD/day}}}$
 - ii) Required carrier surface area = $(993022 \text{ g/day})/(6 \text{ g/m}^2\text{/day}) = 165,504 \text{ m}^2$.
Required carrier volume = $165,504 \text{ m}^2/600 \text{ m}^2\text{/m}^3 = \underline{\underline{275.8 \text{ m}^3}}$
 - iii) For 40% carrier fill: Required tank volume = $275.8 \text{ m}^3/0.40 = \underline{\underline{689.6 \text{ m}^3}}$.
 - iv) The volume of liquid in the reactor can be calculated as:
tank volume – [carrier volume(1 – void %)], Thus the volume of liquid is:
 $689.6 - [275.8(1 - 0.60)] = \underline{\underline{579.3 \text{ m}^3}} = 579.3(3.2808^3) = \underline{\underline{20,456 \text{ ft}^3}}$.

v) The HRT at design ave ww flow can be calculated as:

$$\text{HRT}_{\text{des ave}} = \text{reactor liquid volume} * 7.48 / [Q * 10^6 / (24 * 60)]$$

$$= 20,456 * 7.48 / [1.5 * 10^6 / (24 * 60)] = \underline{147 \text{ min}}$$

$$\text{HRT}_{\text{peak hr}} = \text{HRT}_{\text{des ave}} / \text{peak hour factor} = 147 / 4 = \underline{37 \text{ min}}$$

MBBR Process Design Calculations - U.S. units			
Two-Stage Process for BOD Removal & Nitrification			
Instructions: Enter values in blue boxes. Spreadsheet calculates values in yellow boxes			
I. Wastewater Parameter Inputs			
1. Parameters for Both First and Second Stage			
Design ww Flow Rate, Q =	1.5	MGD	Peak Hour Factor = 4
			Prim. Eff. Alkalinity = 140 mg/L as CaCO ₃
2. Parameters for First Stage:			
Prim. Eff. BOD, S_{o1} =	175	mg/L	Data points for SARR/SALR vs SALR
			SALR (g/m ² /d): 7.5 15.0
			SARR/SALR: 0.925 0.875
			(default values above are based on the table of typical values of % BOD removal vs SALR in Worksheet 3)
Design Value of BOD Surface Area Loading Rate (SALR) =	6	g/m ² /d	Slope, SARR/SALR vs SALR: -0.007
			Intercept, SARR/SALR vs SALR: 0.975
			Est. of SARR/SALR Ratio = 0.935
			(Surf. Area Removal Rate/Surf. Area Loading Rate)
3. Parameters for Second Stage:			
Influent NH ₄ -N Conc. =	35	mg/L	Target Eff NH ₄ -N Conc, NH₄-N_e = 3.3 mg/L
Min Design Temp., T =	45	°F	Click on cell H26 and on arrow to select D.O Conc.
			D.O Conc. in Reactor = 3.0 mg/L
4. Preliminary Calculations - Design Nitrification SALR value			
% NH ₄ -N removal =	91%		NH ₄ -N _e @ SARR _{max} = 0.80 mg/L
Maximum SARR =	0.88	g/m ² /d	SARR @ NH ₄ -N _e , 15°C, SARR₁₅ = 0.88 g/m ² /d
			SARR @ NH ₄ -N _e , T °C, SARR_T = 0.57 g/m ² /d
SARR Temp. Coeff, θ =	1.058		Design Value for nitrification SALR = 0.63 g/m ² /d
II. Carrier Parameter and Tank Shape Inputs for both First and Second Stages			
Carrier Spec. Surf. Area =	600	m ² /m ³	Click on green box and then on arrow to Select Tank Shape: rectangular
			(value from carrier mfr/vendor)
Liquid Depth in Tank =	8	ft	Carrier % Void Space = 60%
Tank L:W ratio =	1.5		(from carrier mfr/vendor - only needed to calculate hydraulic detention time)
			(target L:W - only used if tank is rectangular)

Screenshot of MBBR Process Design Calculations for Two Stage BOD Removal and Nitrification – Part 1

vi) Calculation of the estimated effluent BOD concentration from the first stage as shown above for the single stage BOD removal process gives a value of **11 mg/L**.

b) For the second stage:

i) The design value for the nitrification **SALR** is **0.63 g/m²/d**, calculated in the same way as it was for the single stage nitrification process.

III. Calculation of Carrier Volume and Required Tank Volume & Dimensions					
1. First Stage Calculations - BOD Removal			<i>(Carrier fill % is typically between 30% and 70%. Lower values are more conservative, allowing future capacity expansion or reduction of SALR by adding more carrier.)</i>		
Design Carrier Fill % =	40%	(for first stage)			
BOD Daily Loading =	2189.3	lb/day			
	993022	g/day	Calculated Tank Volume =	689.6	m ³
Carrier Surf. Area needed =	165503.7	m ²	=	24352.9	ft ³
Calculated Carrier Volume =	275.839	m ³	=	182160	gal
Tank Liquid Volume =	20456.5	ft ³	Calculated Tank Width =	45.0	ft
	9740.822	24352.05	Calculated Tank Length =	67.6	ft
Estimate of BOD Surface Area		Nominal Hydraulic Retention Time at			
Removal Rate, SARR =	5.61	g/m ² /d	Design Average Flow =	147	min
Est. of BOD Removal Rate:	928475	g/day	Peak Hourly Flow =	37	min
	2046.9	lb/day	Calculated Effl BOD Conc.:	11	mg/L
(from First Stage)					
<i>If the calculated Effl. BOD conc. is too high, the design value of the SALR should be reduced in cell C18.</i>					
2. Second Stage Calculations - Nitrification					
			Calculated Tank Volume =	1320.5	m ³
Design Carrier Fill % =	40%	(for second stage)	=	46632.1	ft ³
NH ₃ -N Daily Loading =	437.9	lb/day	=	348808	gal
	198604	g/day	Calculated Tank Width =	62.3	ft
Carrier Surf. Area needed =	316914.0	m ²	Calculated Tank Length =	93.5	ft
Calculated Carrier Volume =	528.190	m ³	Nominal Hydraulic Retention Time at		
Tank Liquid Volume =	42736	ft ³	Design Average Flow =	307	min
1st stage tank volume -	18652.17	46630.44	Peak Hourly Flow =	77	min
- 2nd stage tank volume =	-630.9				
<i>To make the 2nd stage tank volume the same as the first stage, use Excel's Goal Seek process to set cell C71 equal to zero by changing the value in cell C60.</i>			Check on BOD SALR:	0.2	g/m ² /d
			(BOD SALR should be < 0.5 g/m ² /d in order to achieve a good nitrification rate)		

Screenshot of MBBR Process Design Calculations for Two Stage BOD Removal and Nitrification – Part 2

ii) The NH₃-N loading rate will be (1.5 MGD)(35 mg/L)(8.34 lb/MG/mg/L)
 = 437.9 lb/day = (437.9 lb/day)*(453.59 g/lb) = **198,604 g NH₃-N/day**

iii) Required carrier surface area = (198,604 g/day)/(0.63 g/m²/day) = 316,914 m².

Required carrier volume = $316914 \text{ m}^2/600 \text{ m}^2/\text{m}^3 = 528.19 \text{ m}^3$
 $= (528.19 \text{ m}^3)(3.2808^3 \text{ ft}^3/\text{m}^3) = \underline{18,652 \text{ ft}^3}$.

iv) For 40% carrier fill: Required tank volume = $18652 \text{ ft}^3/0.40$
 $= \underline{46,632 \text{ ft}^3}$.

vi) The volume of liquid in the reactor can be calculated as:
 tank volume – [carrier volume(1 – void %)], Thus the volume of liquid is:
 $46632 - [18652(1 - 0.60)] = \underline{42,736 \text{ ft}^3}$.

vii) The HRT at design ave ww flow can be calculated as:
 $\text{HRT}_{\text{des ave}} = \text{reactor liquid volume} * 7.48 / [Q * 10^6 / (24 * 60)] =$
 $42736 * 7.48 / [1.5 * 10^6 / (24 * 60)] = \underline{307 \text{ min}}$

$\text{HRT}_{\text{peak hr}} = \text{HRT}_{\text{des ave}} / \text{peak hour factor} = 307/4 = \underline{77 \text{ min}}$

V. Calculation of Alkalinity Requirements			
Input:	Target Effluent Alkalinity =	80	mg/L
Constants needed for Calculations:			
Equiv Wt. of CaCO ₃ =	50	g/equiv.	Equiv Wt. of NaHCO ₃ = 84 g/equiv.
Alkalinity used for Nitrification =	7.14	g CaCO ₃ /g NH ₃ -N	
Calculations			
Alkalinity to be added =	166.3	mg/L as CaCO ₃	
Daily Alkalinity Requirement =	2080.9	lb/day as CaCO ₃	
For sodium bicarbonate use to add alkalinity:			
Daily NaHCO ₃ Requirement =	3495.9	lb/day NaHCO ₃	

Screenshot of MBBR Process Design Calculations for Two Stage BOD Removal and Nitrification – Part 3

vii) Calculation of the alkalinity requirement is shown in part 3 of spreadsheet screenshot, shown above. Using the equivalent weight of CaCO₃ as 50, the equivalent weight of NaHCO₃ as 84, the alkalinity use for nitrification as 7.14 g CaCO₃/g NH₃-N and the target effluent alkalinity as 80 mg/L as CaCO₃, give the calculated alkalinity requirement as 166.3 mg/L as CaCO₃. The rate of alkalinity addition needed can then be calculated as:

$(1.5 \text{ MGD})(166.3 \text{ mg/L}) \cdot 8.34 = \mathbf{2080.9 \text{ lb/day as CaCO}_3}$. Multiplying this by the ratio of the equivalent weight of NaHCO_3 to the equivalent weight of CaCO_3 gives the daily NaHCO_3 requirement as $\mathbf{3495.9 \text{ lb/day NaHCO}_3}$.

9. Denitrification Background Information

In order to carry out denitrification of a wastewater flow (removal of the nitrogen from the wastewater), it is necessary to first nitrify the wastewater, that is, convert the ammonia nitrogen typically present in the influent wastewater to nitrate. Nitrification will only take place at a reasonable rate in an MBBR reactor if the BOD level is quite low. Thus, an MBBR denitrification process will need a reactor for BOD removal, one for nitrification, and one for denitrification. The nitrification reactor will always follow the BOD removal reactor, because of the need for a low BOD level in the nitrification reactor. The denitrification reactor may be either before the BOD removal reactor (called pre-anoxic denitrification) or after the nitrification reactor (called post-anoxic denitrification). Flow diagrams for these two denitrification options are shown in the figure below.

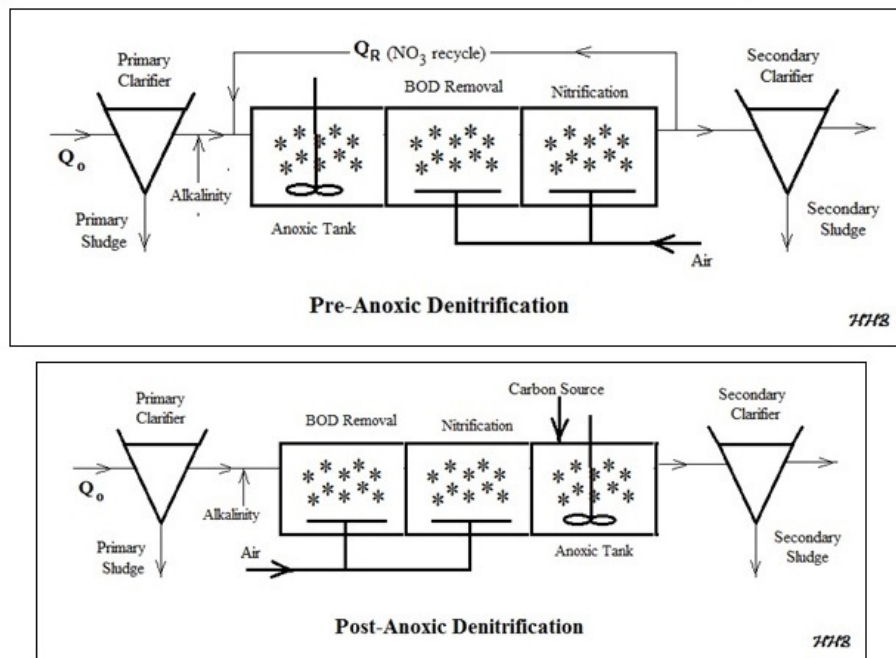

MBBR Denitrification Process Alternatives

A bit more information about the denitrification reactions will be useful for further discussion of these two denitrification options. The denitrification reactions, which convert nitrate ion to nitrogen gas, and hence remove it from the wastewater flow, will take place only in the absence of oxygen, that is, in an anoxic reactor. Also, the denitrification

reactions require a carbon source. With these factors in mind the functioning of the pre-anoxic denitrification process and of the post-anoxic denitrification process are described in the following two paragraphs.

In a **pre-anoxic denitrification** process, the BOD in the primary effluent wastewater is used as the carbon source for denitrification. In this process, however, the primary effluent entering the pre-anoxic reactor still has ammonia nitrogen present, rather than the nitrate nitrogen needed for denitrification. A recycle flow of effluent from the nitrification reactor is used to send nitrate nitrogen to the anoxic denitrification reactor as shown in the flow diagram above.

In a **post-anoxic denitrification** process, the influent to the denitrification reactor comes from the nitrification reactor, so the wastewater influent ammonia nitrogen has been converted to nitrate as required for denitrification. The BOD has also been removed prior to the post anoxic denitrification reactor, however, so an external carbon source is required for the denitrification reactions. Methanol is a commonly used carbon source for post-anoxic denitrification.

The pre-anoxic denitrification process has the advantage of not requiring an external carbon source and it reduces the BOD load to the BOD removal part of the process, because BOD is used in the denitrification reactions. However, the pre-anoxic process requires an influent C/N ratio greater than 4, where C/N is taken to be BOD/TKN, and the post-anoxic process can achieve a more complete nitrogen removal.

From the Odegaard references (#5 and #6 at the end of the course) suitable criteria for determining whether to use pre- or post-anoxic denitrification are as follows:

1. Pre-anoxic denitrification is suitable if **$C/N \geq 4$** and **target % Removal of N < 75%**
2. Post-anoxic denitrification should be used if **$C/N < 4$** or **target % Removal of N > 75%**

10. Post-Anoxic Denitrification Process Design Calculations

Process design of a post-anoxic denitrification MBBR system, requires sizing an MBBR tank for BOD removal, one for nitrification and one for denitrification. For all three of these reactors the key design parameter for sizing the MBBR tank is the surface area loading rate (SALR), typically with units of g/m²/day, that is g/day (of the parameter being removed in that reactor) coming into the MBBR tank per m² of carrier surface area in the reactor.

Using design values for wastewater flow rate and concentration of the removed parameter entering the MBBR tank, the loading rate in g/day can be calculated. Then dividing the loading rate in g/day by the SALR in g/m²/day gives the required carrier surface area in m². The carrier fill %, carrier specific surface area, and carrier % void space can then be used to calculate the required carrier volume, tank volume and the volume of liquid in the reactor. A typical flow diagram for a post-anoxic denitrification MBBR process is shown in the figure on the next page.

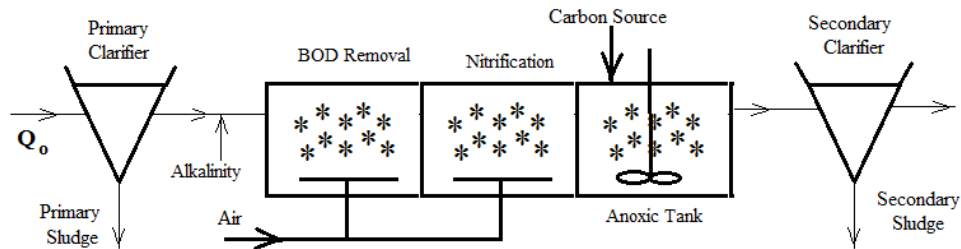

Post-Anoxic Denitrification

HHB

MBBR Flow Diagram for Post-Anoxic Denitrification

Process design calculations for the BOD removal stage and the nitrification stage will be done just as described in **Section 8, Two-Stage BOD Removal and Nitrification Process Design Calculations**, and illustrated with the examples in that section. The process design calculations for denitrification, which is the third stage in a post-anoxic denitrification process, are similar to those previously discussed and illustrated for the BOD removal stage and the nitrification stage. The graph shown in the figure below (prepared using values from a similar graph in Rusten and Paulsrud's presentation in Ref #4 at the end of this course) will be used to obtain values for SARR/SALR vs SALR for the denitrification stage.

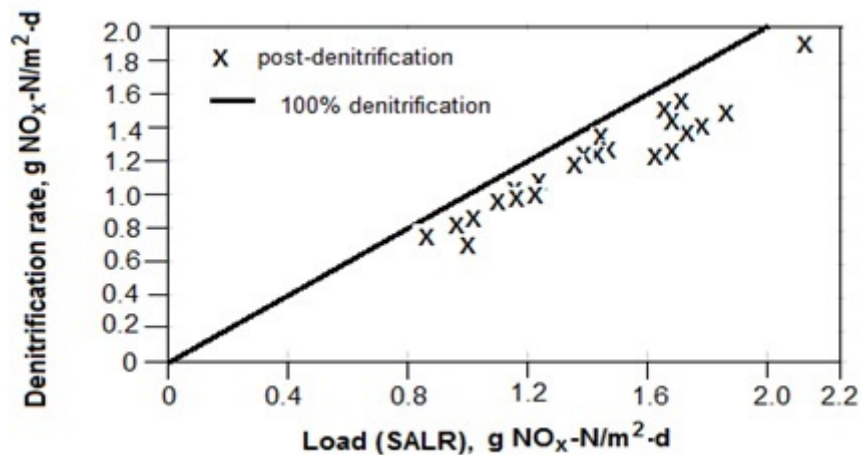

SARR vs SALR for Post-Anoxic Denitrification

Table 4 below shows typical SALR design values for pre-anoxic denitrification and post-anoxic denitrification in MBBR reactors. Reference #2 at the end of this book is the source for the values in **Table 4**.

Table 4. Typical Design SALR Values for Denitrification

Typical Design Values for MBBR reactors at 15°C		
Purpose	Treatment Target % Removal	Design SALR g/m ² -d
Denitrification		
Pre-DN (C/N > 4)	70 (NO ₃ -N)	0.90 (NO ₃ -N)
Post-DN (C/N > 3)	90 (NO ₃ -N)	2.00 (NO ₃ -N)

Example #7: A design wastewater flow of 1.5 MGD containing 175 mg/L BOD, 35 mg/L TKN, and alkalinity of 140 mg/L as CaCO₃ (in the primary effluent) is to be treated in a post-anoxic denitrification MBBR process. The design SALR for the first stage is to be 6 g BOD/m²/d. For the second stage, the SALR should be calculated for a target effluent NH₄-N conc. of 3.3 mg/L, min. design temperature of 45°F, and D.O. in reactor of 3.0 mg/L. For the post-anoxic stage, the SALR is to be 2 g NO₃-N/m²/d and the target effluent NO₃-N conc. is to be 5.0 mg/L.

For the third (Denitrification) stage calculate each of the following:

- i) The nitrate loading
- ii) The required carrier volume for a carrier with specific surface area of 600 m²/m³
- iii) The required MBBR tank volume for a design carrier fill % of 40%
- iv) The volume of liquid in the MBBR reactor for design carrier % void space of 60%.
- v) The average hydraulic retention time at design average wastewater flow and at design peak hourly flow if the design peak hour factor is 4.
- vi) The estimated effluent NO₃-N concentration from the denitrification stage.
- vii) The alkalinity requirement in lb/day as CaCO₃ and in lb/day NaHCO₃, for target effluent alkalinity of 80 mg/L as CaCO₃.
- viii) The methanol requirement in lb/day for methanol use as the carbon source.

Note that the process design calculations for the BOD removal stage and the nitrification stage of this process will be the same as those used in Example #6 in the section on a two-stage BOD removal and nitrification process.

Solution - The solution is shown in the three figures on the next several pages, which are screenshots of different parts of an Excel worksheet used to carry out the calculations for this example. The first figure is from the top part of the worksheet and shows the user inputs and the calculation of the estimated **SARR/SALR** ratio for the denitrification stage, resulting in a value of **SARR/SALR = 0.85**. The second figure is from the middle of the worksheet and shows the answers for parts i) through vi), as follows:

i) The NO₃-N loading rate will be $(1.5 \text{ MGD})(35 - 3.3 \text{ mg/L})(8.34 \text{ lb/MG/mg/L}) = 396.6 \text{ lb/day} = (396.6 \text{ lb/day}) \cdot (453.59 \text{ g/lb}) = \underline{\underline{179,879 \text{ g NO}_3\text{-N/day}}$

ii) Required carrier surface area = $(179,879 \text{ g/day}) / (2 \text{ g/m}^2\text{/day}) = 89,939 \text{ m}^2$.
 Required carrier volume = $89,939 \text{ m}^2 / 600 \text{ m}^2\text{/m}^3 = \underline{\underline{149.90 \text{ m}^3}}$

iii) For 40% carrier fill: Required tank volume = $149.90 \text{ m}^3 / 0.40 = \underline{\underline{374.75 \text{ m}^3}}$.

iv) The volume of liquid in the reactor can be calculated as:
 tank volume – [carrier volume(1 – void %)], Thus the volume of liquid is:
 $374.75 - [149.90(1 - 0.60)] = \underline{\underline{314.79 \text{ m}^3}} = 314.79 \cdot 3.2808^3 = \underline{\underline{11,117 \text{ ft}^3}}$.

v) The HRT at design ave ww flow can be calculated as:
 $\text{HRT}_{\text{des ave}} = \text{reactor liquid volume} \cdot 7.48 / [Q \cdot 10^6 / (24 \cdot 60)]$
 $= 11,117 \cdot 7.48 / [1.5 \cdot 10^6 / (24 \cdot 60)] = \underline{\underline{80 \text{ min}}}$

$\text{HRT}_{\text{peak hr}} = \text{HRT}_{\text{des ave}} / \text{peak hour factor} = 80 / 4 = \underline{\underline{20 \text{ min}}}$

vi) Calculation of the estimated effluent NO₃-N concentration from the second stage, as shown above for the BOD removal process, is shown in the **Figure 35** spreadsheet screenshot below and gives a value of **4.8 mg/L**,

vii) Calculation of the alkalinity requirement is shown in the third spreadsheet screenshot below. Using the equivalent weight of CaCO₃ as 50, the equivalent weight of NaHCO₃ as 84, the alkalinity use for nitrification as 7.14 g CaCO₃/g NH₃-N, the alkalinity produced by denitrification as 3.56 g CaCO₃/g NO₃-N denitrified, and the target effluent alkalinity as 80 mg/L as CaCO₃, give the calculated alkalinity requirement as 81.9 mg/L as CaCO₃. The rate of alkalinity addition needed can then be calculated as:

$(1.5 \text{ MGD})(81.9 \text{ mg/L}) \cdot 8.34 = \underline{\underline{1024.9 \text{ lb/day as CaCO}_3}}$. Multiplying this by the ratio of the equivalent weight of NaHCO₃ to the equivalent weight of CaCO₃ gives the daily NaHCO₃ requirement as **1721.8 lb/day NaHCO₃**.

viii) Calculation of the methanol requirement in lb/day is shown at the bottom of the third screenshot below. As shown, the calculations use the constants, 4.6 lb COD/lb NO₃-N removed and 1.5 lb COD/lb Methanol. The required methanol dosage is then calculated as: $4.6/1.5 = 3.1$ lb methanol /lb NO₃-N removed. The methanol requirement in lb/day is then equal to 3.1 times the previously calculated NO₃-N removal rate of 337.1 lb/day, or **1033.7 lb/day**.

MBBR Process Design Calculations - U.S. units					
Post-Anoxic Denitrification Process					
Instructions: Enter values in blue boxes. Spreadsheet calculates values in yellow boxes					
I. Wastewater Parameter Inputs					
1. Parameters for All Three Stages					
Design ww Flow Rate, Q_o =	1.5	MGD	Prim. Effl. BOD, S_o =	175	mg/L
Prim. Effl. TKN Conc. =	35	mg/L	Prim. Effl. NO_3 -N Conc. =	0	mg/L
Peak Hour Factor =	4		Prim. Effl. Alkalinity =	140	mg/L as $CaCO_3$
2. Parameters for First (BOD Removal) Stage:					
			Data points for SARR/SALR vs SALR		
Design Value of BOD Surface			SALR ($g/m^2/d$):	7.5	15.0
Area Loading Rate (SALR) =	6	$g/m^2/d$	SARR/SALR:	0.925	0.875
See information on typical design values for SALR at right.		(default values above are from the table of typical values of % BOD removal vs SALR shown at the right from ref #2)			
Est. of SARR/SALR Ratio =	0.935				
(Surf. Area Removal Rate/Surf. Area Loading Rate)		Slope, SARR/SALR vs SALR:		-0.007	
		Intercept, SARR/SALR vs SALR:		0.975	
3. Parameters for Second (Nitrification) Stage:					
Influent NH_4 -N Conc. =	25	mg/L	Target Effl NH_4 -N Conc, NH_4-N_e =	3.3	mg/L
Min Design Temp., T =	45	$^{\circ}F$	Click on cell H26 and on arrow to select D.O Conc.		
			D.O Conc. in Reactor =	3.0	mg/L
4. Preliminary Calculations - Design Nitrification SALR value					
% NH_4 -N removal =	87%		NH_4-N_e @ $SARR_{max}$ =	0.80 mg/L	
Maximum SARR =	0.88	$g/m^2/d$	SARR @ NH_4-N_e , $15^{\circ}C$, $SARR_{15}$ =	0.88 $g/m^2/d$	
			SARR @ NH_4-N_e , $T^{\circ}C$, $SARR_T$ =	0.57 $g/m^2/d$	
SARR Temp. Coeff, θ =	1.058		Design Value for nitrification SALR =	0.65 $g/m^2/d$	
5. Parameters for Third (Post-Anoxic) Stage:					
			Data points for SARR/SALR vs SALR		
Target Effl. NO_3 -N Conc. =	5.0	mg/L	SALR ($g/m^2/d$):	1	2.0
Design Value of BOD Surface			SARR/SALR:	0.880	0.850
Area Loading Rate (SALR) =	2.0	$g/m^2/d$	(default values above are from a graph of Post-Anoxic SARR vs SALR in ref #6 below right) (The graph is shown at the right.)		
See information on typical design values for SALR at right.					
Est. of SARR/SALR Ratio =	0.85		Slope, SARR/SALR vs SALR:		
(Surf. Area Removal Rate/Surf. Area Loading Rate)		Intercept, SARR/SALR vs SALR:		0.910	

Screenshot – Post-Anoxic Denitrification Design Calculations – Part 1

II. Determine whether to use Pre-Anoxic or Post-Anoxic Denitrification					
Carbon:Nitrogen Ratio, C/N =	5.0		Use this Worksheet for Post-Anoxic Denitrification calculations		
Target % N removal =	86%				
III. Carrier and Tank Shape Parameter Inputs for all Three Stages					
Carrier Spec. Surf. Area = (from carrier mfr/vendor)	600	m ² /m ³	Click on green box and then on arrow to Select Tank Shape:	rectangular	
Liquid Depth in Tank =	8	ft	Carrier % Void Space =	60%	
Tank L:W ratio =	1.5		(from carrier mfr/vendor - only needed to calculate hydraulic detention time)		
IV. Calculation of Carrier Volume and Required Tank Volume & Dimensions					
3. Third Stage (Post-Anoxic) Calculations					
Design Carrier Fill % =	32%	(for third stage)	Required Tank Volume =	472.86	m ³
NO ₃ -N Daily Loading =	396.6	lb/day	Tank Liquid Volume =	16699.0	ft ³
NO ₃ -N Daily Loading =	179879	g/day		124909	gal
Carrier Surf. Area needed =	89939	m ²	Calculated Tank Width =	37.3	ft
Calculated Carrier Volume =	149.90	m ³	Calculated Tank Length =	56.0	ft
Tank Liquid Volume =	14581.6	ft ³	Nominal Hydraulic Retention Time at		
Estimate of NO ₃ -N Surface Area Removal Rate, SARR =	1.70	g/m ² /d	Design Average Flow =	105	min
Est. of NO ₃ -N Removal Rate:	152897	g/day	Peak Hourly Flow =	26	min
	337.1	lb/day	Calculated Effl NO ₃ -N Conc.:	4.8	mg/L
1st stage tank volume -			If the calculated Effl. NO ₃ -N conc. is too high, the design value of SALR (in cell C36) should be reduced.		
3rd stage tank volume =	-13.1				
To make the 3rd stage tank volume the same as the first stage tank volume, use Excel's Goal Seek process to set cell C101 equal to zero by changing the value in cell C90.					

Screenshot – Post-Anoxic-Denitrification Design Calculations – Part 2

VII. Calculation of Alkalinity Requirements			
Input:	Target Effluent Alkalinity =	80	mg/L as CaCO ₃
Constants needed for Calculations:			
Equiv Wt. of CaCO ₃ =	50	g/equiv.	Equiv Wt. of NaHCO ₃ = 84 g/equiv.
Alkalinity used for Nitrification =	7.14	g CaCO ₃ /g NH ₃ -N removed	
Alkalinity produced by Denitrification =	3.57	g CaCO ₃ /g NO ₃ -N removed	
Calculations			
Alkalinity to be added =	81.9	mg/L as CaCO ₃	
Daily Alkalinity Requirement =	1024.9	lb/day as CaCO ₃	
For sodium bicarbonate use to add alkalinity:			
Daily NaHCO ₃ Requirement =	1721.8	lb/day NaHCO ₃	
VII. Calculation of Carbon Source Requirements			
Inputs:	Carbon Source to be used:	Methanol	
	COD Requirement for Denitrification =	4.6	lb COD/lb NO ₃ -N removed
	COD Content of Carbon Source =	1.5	lb COD/lb Carbon Source
Calculations			
Carbon Source Dosage =	3.1	lb Carbon Source/lb NO ₃ -N removed	
Daily Carbon Source Requirement =	1033.7	lb/day	

Screenshot – Post-Anoxic Denitrification Design Calculations – Part 3

11. Pre-Anoxic Denitrification Process Design Calculations

The process design calculations for pre-anoxic denitrification, are similar to those just discussed for a post-anoxic denitrification process. The graph shown in the figure below (prepared using values from a similar graph in Rusten and Paulsrud’s presentation in Ref #4 at the end of this course) will be used to obtain values for SARR/SALR vs SALR for the pre-anoxic denitrification stage

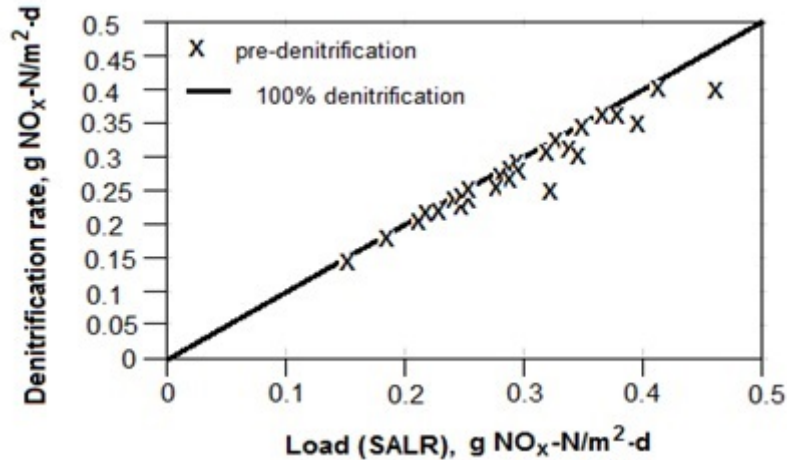

SARR/SALR vs SALR for Pre-Anoxic Denitrification

A typical flow diagram for a pre-anoxic denitrification MBBR process is shown in the figure below. As discussed previously for a post-anoxic denitrification MBBR system, process design of a pre-anoxic denitrification MBBR system also requires sizing an MBBR tank for BOD removal, one for nitrification and one for denitrification. Process design for the nitrification stage is essentially the same as just discussed for the post-anoxic denitrification process.

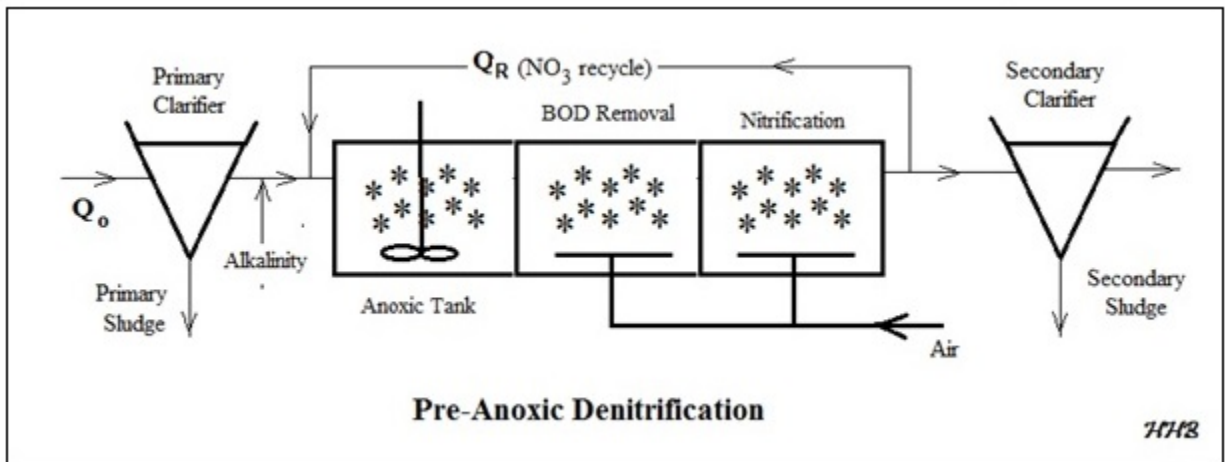

MBBR Flow Diagram for Pre-Anoxic Denitrification

Process Design calculations for the BOD removal stage will be a bit different from those for the BOD removal stage in the post-anoxic process, because some of the incoming

BOD is used as the carbon source for the denitrification reactions in the pre-anoxic tank. For the pre-anoxic process, the BOD loading rate (in lb/day) should be calculated as:

$$\text{BOD Daily Loading} = (Q_o * S_o * 8.34) - (0.67 * (20/7) * \text{NO}_3\text{-N removal rate})$$

The second term is the estimated BOD removal rate in the anoxic reactor through its use in the denitrification reactions. This gives a lower BOD loading rate than that for the post-anoxic process with the same primary clarifier effluent coming in. Hence, the required tank size for BOD removal will be smaller for the pre-anoxic process.

The main difference from the post-anoxic denitrification process design calculations is for the denitrification stage, which will be discussed and illustrated with **Example #8** calculations below.

Example #8: Carry out the process design as described below for the denitrification stage of a pre-anoxic denitrification process with the wastewater flow and concentrations given in **Example #7**. [1.5 MGD containing 175 mg/L BOD and 35 mg/L TKN (in the primary effluent)]. Consider that the primary effluent alkalinity is 140 mg/L as CaCO₃ and the design SALR for the denitrification stage is to be 0.9 g NO₃-N/m²/d. The nitrification stage was designed for an effluent NH₃-N concentration of 3.3 mg/L, a D.O. of 3.0 mg/L, and a minimum WW temperature of 45°F.

For the first stage (denitrification) calculate each of the following:

- i) The nitrate loading rate
- ii) The required carrier volume for a carrier with specific surface area of 600 m²/m³
- iii) The required MBBR tank volume for a design carrier fill % of 40%
- iv) The volume of liquid in the MBBR reactor for design carrier % void space of 60%.
- v) The average hydraulic retention time at design average wastewater flow and at design peak hourly flow if the design peak hour factor is 4.
- vi) The required NO₃-N recycle rate needed to achieve a target effluent NO₃-N concentration of 9 mg/L.
- vii) The alkalinity requirement in lb/day as CaCO₃ and in lb/day NaHCO₃, for a target effluent alkalinity of 80 mg/L as CaCO₃.

Solution - The solution is shown in the three figures on the next several pages, which are screenshots of different parts of an Excel worksheet used to carry out the calculations for this example. The first figure below is from the top part of the worksheet and shows the user inputs and the calculation of the estimated **SARR/SALR** ratio for the denitrification stage (calculated to be **0.927**). Note also that a user input value is needed for the estimated NO₃-N recycle ratio. This initial estimated value is used in an iterative calculation farther down on the worksheet (in the second screenshot below) to determine

the required NO₃-N recycle ratio needed to achieve the target effluent NO₃-N concentration.

MBBR Process Design Calculations - U.S. units					
Pre-Anoxic Denitrification Process					
Instructions: Enter values in blue boxes. Spreadsheet calculates values in yellow boxes					
I. Wastewater Parameter Inputs					
1. Parameters for All Three Stages					
Design ww Flow Rate, Q _o =	1.5	MGD	Prim. Effl. BOD, S _o =	175	mg/L
Prim. Effl. TKN Conc. =	35	mg/L	Prim. Effl. NO ₃ -N Conc. =	0	mg/L
Peak Hour Factor =	4		Prim. Effl. Alkalinity =	140	mg/L as CaCO ₃
2. Parameters for First (Pre-Anoxic) Stage:					
			Data points for SARR/SALR vs SALR		
Target Effl. NO ₃ -N Conc. =	9	mg/L	SALR (g/m ² /d):	0.2	0.5
Est. of NO ₃ -N Recycle Ratio:	2.72		SARR/SALR:	0.95	0.94
(Q _R /Q _o) - An estimate is needed here to start the iterative calculation in Sec IV below			(default values above are from a graph of Pre-Anoxic SARR vs SALR in ref #6 below right)		
Design Value of NO ₃ -N Surface			(The graph is shown at the right.)		
Area Loading Rate (SALR) =	0.9	g/m ² /d	Slope, SARR/SALR vs SALR:	-0.033	
See information on typical design values for SALR at right.			Intercept, SARR/SALR vs SALR:	0.957	
			Est. of SARR/SALR Ratio =	0.927	
(Surf. Area Removal Rate/Surf. Area Loading Rate)					

The figure, on the next page, is from the middle of the worksheet and shows the answers for parts i) through vi). The calculations and results are as follows:

- i) Most of the nitrate loading to the pre-anoxic denitrification tank is typically in the NO₃-N recycle flow rather than in the primary effluent flow entering the tank. The NO₃-N loading rate will be:

$$(1.5 \text{ MGD})(\text{Prim Effl NO}_3\text{-N})(8.34 \text{ lb/MG/mg/L}) + (1.5 \text{ MGD})(\text{Recycle Ratio})(\text{Target Effl NO}_3\text{-N})(8.34) = 306.5 \text{ lb/day}$$

$$= (306.5 \text{ lb/day}) \times (453.59 \text{ g/lb}) = \mathbf{139,003 \text{ g NO}_3\text{-N/day}}$$
- ii) Required carrier surface area = $(139,003 \text{ g/day}) / (0.9 \text{ g/m}^2\text{/day}) = 154,447 \text{ m}^2$.
 Required carrier volume = $154,447 \text{ m}^2 / 600 \text{ m}^2\text{/m}^3 = 257.41 \text{ m}^3 = (257.41 \text{ m}^3)(3.2808^3 \text{ ft}^3\text{/m}^3) = \mathbf{9090 \text{ ft}^3}$.
- iii) For 40% carrier fill: Required tank volume = $9090 \text{ ft}^3 / 0.40 = \mathbf{22,726 \text{ ft}^3 (643.5 \text{ m}^3)}$

II. Determine whether to use Pre-Anoxic or Post-Anoxic Denitrification				
Carbon:Nitrogen Ratio, C/N =	5.0		Use this Worksheet for Pre-Anoxic Denitrification calculations	
Target % N removal =	74%			
III. Carrier and Tank Shape Parameter Inputs for all Three Stages				
Carrier Spec. Surf. Area = (from carrier mfr/vendor)	600	m ² /m ³	Click on green box and then on arrow to Select Tank Shape:	rectangular
Liquid Depth in Tank =	8	ft	Carrier % Void Space =	60%
Tank L:W ratio = (target L:W - only used if tank is rectangular)	1.5		(from carrier mfr/vendor - only needed to calculate hydraulic detention time)	
IV. Calculation of Carrier Volume and Required Tank Volume & Dimensions				
1. First Stage (Pre-Anoxic Tank) Calculations			(Carrier fill % is typically between 30% and 70%. Lower values are more conservative, allowing future capacity expansion or reduction of SALR by adding more carrier.)	
Design Carrier Fill % =	40%	(for first stage)	Calculated Tank Volume =	643.5 m ³
NO ₃ -N Daily Loading =	306.5	lb/day		22726.1 ft ³
NO ₃ -N Daily Loading =	139002.7	g/day		169991 gal
Carrier Surf. Area needed =	154447.4	m ²	Calculated Tank Width =	43.5 ft
Calculated Carrier Volume =	257.412	m ³	Calculated Tank Length =	65.3 ft
Tank Liquid Volume =	19089.9	ft ³	Nominal Hydraulic Retention Time at	
Estimate of NO ₃ -N Surface Area			Design Average Flow =	137 min
Removal Rate, SARR =	0.83	g/m ² /d	Peak Hourly Flow =	34 min
Req'd NO ₃ -N Removal Rate: (for Effl. NO ₃ -N = Target Value)	283.98	lb/day	Est. of NO ₃ -N Removal Rate:	283.98 g/day
			Est. Rem Rate - Req'd Rate:	0.0000 g/day
NOTE: Use Excel's "Goal Seek" to find Q_R/Q₀ as follows: Place the cursor on cell H73 and click on "Goal Seek" (in the "tools" menu of older versions and under "Data - What if Analysis" in newer versions of Excel). Enter values to "Set cell:" H73, "To value:" 0, "By changing cell:" c17, and click on "OK". The calculated value of Q_R/Q₀ will appear in cell C17 and cell H73 should equal zero if the process worked properly. Note that an initial estimate of Q_R/Q₀ is needed in cell C17 to start the iterative process.				

iv) The volume of liquid in the reactor can be calculated as:
 tank volume – [carrier volume(1 – void %)]. Thus, the volume of liquid is:
 $22,726 - [9090(1 - 0.60)] = \mathbf{19,090 \text{ ft}^3}$. ($\mathbf{540.6 \text{ m}^3}$)

vi) The HRT at design ave WW flow can be calculated as:
 $HRT_{\text{des ave}} = \text{reactor liquid volume} * 7.48 / [Q * 10^6 / (24 * 60)]$
 $= 19,090 * 7.48 / [1.5 * 10^6 / (24 * 60)] = \mathbf{137 \text{ min}}$

$$\text{HRT}_{\text{peak hr}} = \text{HRT}_{\text{des ave}} / \text{peak hour factor} = 137/4 = \underline{\mathbf{34 \text{ min}}}$$

vii) The required NO₃-N recycle ratio is calculated with the iterative process described in blue at the bottom of the last figure above. For this iterative process, the NO₃-N removal rate is calculated two different ways, one using the estimated SARR and the carrier surface area while the other uses the wastewater flow rate times the influent TKN concentration minus the sum of the effluent nitrate and ammonia nitrogen concentrations. Excel's Goal Seek process is then used to set the difference between the two different calculations equal to zero by changing the estimated value of the NO₃-N recycle ratio. This process results in the required NO₃-N recycle ratio calculated to be **2.72**.

viii) Calculation of the alkalinity requirement is shown in the third screenshot figure, below on this page. Using the equivalent weight of CaCO₃ as 50, the equivalent weight of NaHCO₃ as 84, the alkalinity use for nitrification as 7.14 g CaCO₃/g NH₃-N, the alkalinity produced by denitrification as 3.56 g CaCO₃/g NO₃-H, and the target effluent alkalinity as 80 mg/L as CaCO₃, give the calculated alkalinity requirement as **97.1 mg/L as CaCO₃**. The rate of alkalinity addition needed can then be calculated as:

$$(1.5 \text{ MGD})(91.1 \text{ mg/L}) * 8.34 = \underline{\mathbf{1214.5 \text{ lb/day as CaCO}_3}}$$

Multiplying this by the ratio of the equivalent weight of NaHCO₃ to the equivalent weight of CaCO₃ gives the daily NaHCO₃ requirement as **2040.3 lb/day NaHCO₃**.

VII. Calculation of Alkalinity Requirements			
Input:	Target Effluent Alkalinity =	80	mg/L
Constants needed for Calculations:			
Equiv Wt. of CaCO ₃ =	50	g/equiv.	Equiv Wt. of NaHCO ₃ = 84 g/equiv.
Alkalinity used for Nitrification =	7.14	g CaCO ₃ /g NH ₃ -N removed	
Alkalinity produced by Denitrification =	3.57	g CaCO ₃ /g NO ₃ -N removed	
Calculations			
Alkalinity to be added =	97.1	mg/L as CaCO ₃	
Daily Alkalinity Requirement =	1214.5	lb/day as CaCO ₃	
For sodium bicarbonate use to add alkalinity:			
Daily NaHCO ₃ Requirement =	2040.3	lb/day NaHCO ₃	

12. Summary

The MBBR (moving bed biofilm reactor) process is an attached growth process that uses plastic carriers to provide a surface on which biofilm grows. The plastic carriers are kept suspended in the aeration tank by an aerator for an aerobic process or by mechanical mixing for an anoxic or anaerobic process. The plastic carriers are kept in the system by a sieve at the outlet of the tank. The MBBR process doesn't require sludge recycle, because the biomass remains in the system attached to the plastic carriers. The required reactor size for an MBBR process is typically significantly smaller than that for an activated sludge process treating the same wastewater flow, or for other common attached growth processes like the RBC or trickling filter. It can be used for BOD removal, biological nitrification, biological denitrification, and biological phosphorus removal.

This course provides discussion of and detailed examples of process design calculations for a single stage BOD removal MBBR system, a two-stage BOD removal MBBR system, a single stage tertiary nitrification MBBR system, a two-stage BOD removal/Nitrification MBBR system a post-anoxic denitrification MBBR system and a pre-anoxic denitrification MBBR system.

13. References

1. Odegaard, Hallvard, "Compact Wastewater Treatment with MBBR," DSD International Conference, Hong Kong, 12, 11-14-2014.
2. Odegaard, H., "The Moving Bed Biofilm Reactor," in Igarashi, T, Watanabe, Y, Asano, T, and Tambo N., "Water Environmental Engineering and Reuse of Water," Hokkaido Press 1999, p 250-305.
3. Steichen, M. & Phillips, H., Black & Veach, "Process and Practical Considerations for IFAS and MBBR Technologies," Headworks International Presentation, 03/18/2010.
4. Rusten, B. and Paulsrud, B, *Improved Nutrient Removal with Biofilm Reactors*, Aquateam – Norwegian Water Technology Center, Oslo, Norway.
5. McQuarrie, J.P. and Boltz, J.PI, *Moving Bed Biofilm Reactor Technology: Process Applications, Design and Performance*, Water Environment Research, Vol 83, No. 6, June 2011.

6. Bengtson, Harlan H., “[MBBR Wastewater Treatment Design Spreadsheet](#),” An online article at www.EngineeringExcelSpreadsheets.com, 2015.
7. Bengtson, Harlan H., “[Spreadsheets for MBBR Wastewater Treatment Process Design Calculations](#),” available as a paperback or as an Amazon Kindle e-book, 2017.
8. Bengtson, Harlan H., “[Spreadsheets for MBBR Denitrification Design Calculations](#),” an Amazon Kindle e-book, 2017.
9. Bengtson, Harlan H., “[Biological Wastewater Treatment Process Design Calculations](#),” available as an Amazon Kindle e-book or as a paperback book, 2017.